



## Specification Catalog

*5 Series with OptiHeat*  
*NEW Series*  
**504W11**

Geothermal heat pump  
3-5 tons



## Table of Contents

---

Model Nomenclature . . . . .	5
AHRI/ISO 13256-2 Data . . . . .	6
The 5 Series OptiHeat . . . . .	8
Inside the 5 Series OptiHeat. . . . .	10
Water Quality . . . . .	11
Aurora Control System . . . . .	12
Application Notes. . . . .	20
Dimensional Data . . . . .	27
Physical Data . . . . .	28
Electrical Data . . . . .	28
Antifreeze Correction . . . . .	29
Water Pressure Drop . . . . .	30
Pressure Drop . . . . .	31
Heating Operating Envelope . . . . .	32
Cooling Operating Envelope . . . . .	32
Reference Calculations . . . . .	33
Legend and Notes . . . . .	33
Performance Data. . . . .	34
Wiring Schematics . . . . .	40
Accessories and Options. . . . .	42
External Control . . . . .	43
Engineering Guide Specifications . . . . .	45
Revision Guide. . . . .	48

# 5 Series OptiHeat

## 504W11 Geothermal Heat Pump



WaterFurnace is proud to introduce the latest in geothermal heat pump technology by launching the 5 Series OptiHeat line of heat pumps which are the most efficient, Energy Star rated water to water heat pumps available on the market. Patented OptiHeat refrigeration circuit provides 10-15% higher efficiency and can generate 10° -15° F hotter water than traditional systems. OptiHeat utilizes Copeland vapor injection (VI) scroll compressor technology to provide optimal performance. Vapor injection theory uses an intermediate refrigerant heat exchanger to boost refrigeration capacity which increases overall heat pump efficiency. As the name OptiHeat implies, these units are optimized for heating performance. VI technology enables the heat pump an expanded operating range allowing leaving water temperatures of 150°F. A 20°F improvement over conventional systems while maintaining the same environmentally friendly R-410A refrigerant that is industry standard. Copeland VI compressors are specifically designed to operate under higher compression ratios which allows for higher temperature operation without sacrificing reliability. 5 Series 504W11 OptiHeat units have been tested and approved for higher pressure operation per UL 1995 which is the standard for heating/cooling products in the United States.

OptiHeat units are equipped with electronic expansion valve controlled by the Aurora Base microprocessor to offer precise control of the vapor injection circuit. While the units are optimized for heating performance, cooling is still an option with reversible units. In the cooling mode, VI technology is turned off to maintain simplicity and efficient performance.

1. Compressor: Vapor injected, single speed scroll, mounted on a double isolation system. Super Quiet Sound Package for improved noise reduction.
2. Water Lines: Flush mount connections allow one wrench leak-free connections without a back-up.
3. Cabinet: Heavy gauge, environmentally responsible galvanized steel for maximum corrosion resistance.
4. Soft Start: IntelliStart™ reduces the amount of current needed to activate the unit by 60-70%. This helps alleviate light flicker, reduces start-up noise and increases compressor life. Helpful in applications when WaterFurnace units are to run off-the-grid.
5. ThermaShield™: Proprietary coating applied to water-to-refrigerant heat exchanger that protects against condensations in extended range applications (below 50°F).
6. Discharge line mufflers to help quiet compressor discharge gas pulsations
7. Electronic expansion valve for optimal superheat control of VI circuit
8. Controls: Aurora Base Control with Aurora Expansion Board is standard.

#### Key Benefits:

- 3 models sizes from 040-066 MBtu/hr.
- Same NSW cabinet footprint for easy retrofit of legacy product.
- Field switchable control box

As a leader in the industry, WaterFurnace is dedicated to innovation, quality, and customer satisfaction. In fact, every unit built is exposed to a wide range of quality control procedures throughout the assembly process and is then subjected to a rigorous battery of computerized run tests to certify that it meets or exceeds performance standards for efficiency and safety, and will perform flawlessly at startup. As further affirmation of our quality standards, each unit carries our exclusive Quality Assurance emblem, signed by the final test technician.

WaterFurnace International's corporate headquarters ISO 9001:2008 and manufacturing facility is located in Fort Wayne, IN. A scenic three-acre pond located in front of the building serves as our geothermal heating and cooling source to comfort-condition our 110,000 square feet of manufacturing and office space. As a pioneer, and now a leader in the industry, the team of WaterFurnace engineers, customer support staff, and skilled assembly technicians is dedicated to providing the finest comfort systems available.

By choosing or specifying WaterFurnace 5 Series products, you can be assured that your customer is investing in the ultimate comfort system and peace of mind for many years to come.



# Model Nomenclature

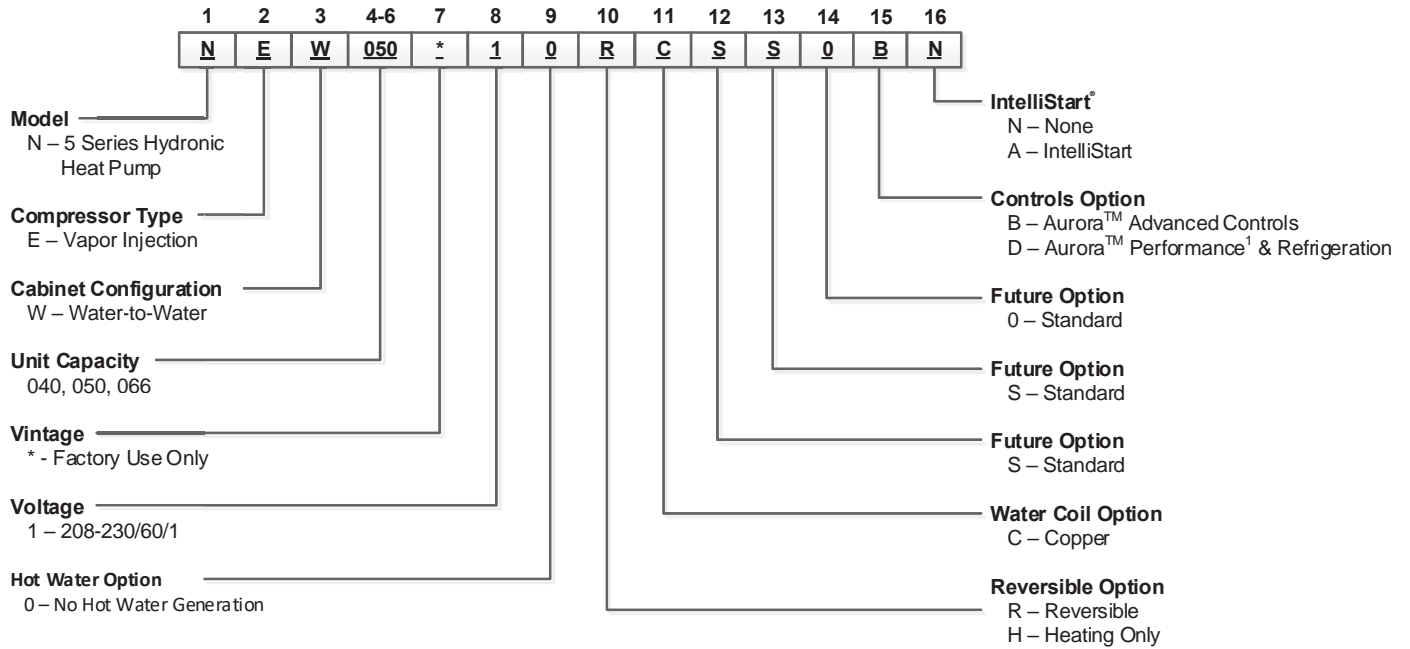

Rev.: A 9/27/18 ADL

**NOTE: 1 - Flow meter for Performance Refrigeration option is shipped inside the unit and must be externally field installed.**

Voltage	NEW		
	040	050	066
208-230/60/1	••	•	•

- - Voltage available in this size
- - Voltage and soft start available in this size



All 5 Series products are safety listed under UL1995 thru ETL and performance listed with AHRI in accordance with standard 13256-2. The 5 Series is also ENERGY STAR® rated.

## AHRI/ISO 13256-2 Performance Ratings

The performance standard AHRI/ASHRAE/ISO 13256-2 became effective January 1, 2000. This new standard has three major categories: Water Loop, Ground Water, and Ground Loop.

### Unit of Measure: The Cooling COP

The cooling efficiency is measured in EER (US version measured in Btu/h per Watt. The Metric version is measured in a cooling COP (Watt per Watt) similar to the traditional COP measurement.

### Pump Power Correction Calculation

Within each model, only one water flow rate is specified for all three groups and pumping Watts are calculated using the following formula. This additional power is added onto the existing power consumption.

- Pump power correction = (gpm x 0.0631) x (Press Drop x 2990) / 300

Where 'gpm' is waterflow in gpm and 'Press Drop' is the pressure drop through the unit heat exchanger at rated water flow in feet of head.

### ISO Capacity and Efficiency Calculations

The following equations illustrate cooling calculations:

- ISO Cooling Capacity = Cooling Capacity (Btuh) x [Fan Power Correction (Watts) x 3.412]
- ISO EER Efficiency (Btuh/W) = ISO Cooling Capacity (Btuh) x [Power Input (Watts) - Fan Power Correction (Watts) + Pump Power Correction (Watts)]

The following equations illustrate heating calculations:

- ISO Heating Capacity = Heating Capacity (Btuh) x [Fan Power Correction (Watts) x 3.412]
- ISO COP Efficiency (Btuh/Btuh) = ISO Heating Capacity (Btuh) x 3.412/[Power Input (Watts) - Fan Power Correction (Watts) + Pump Power Correction (Watts)]

### Test Conditions

	ISO/AHRI 13256-2 WLHP	ISO/AHRI 13256-2 GWHP	ISO/AHRI 13256-2 GLHP
<b>Cooling</b>			
Liquid Entering Indoor Side - °F <i>Standard Rating Test</i>	53.6	53.6	53.6
Liquid Entering Heat Exchanger - °F <i>Part-load Rating Test</i>	86	59	77
Liquid Entering Heat Exchanger Fluid Flow Rate	86 *	59 *	68 *
<b>Heating</b>			
Liquid Entering Indoor Side - °F <i>Standard Rating Test</i>	104	104	104
Liquid Entering Outdoor-side Heat Exchanger - °F <i>Part-load Rating Test</i>	68	50	32
Liquid Entering Outdoor-side Heat Exchanger Fluid Flow Rate	68 *	50 *	41 *

### Conversions

Water Flow (lps) = gpm x 0.0631

Press Drop (Pascals) = Press Drop (ft hd) x 2990

**NOTES:** \*Flow rate is specified by the manufacturer  
 WLHP = Water Loop Heat Pump; GWHP = Ground Water Heat Pump;  
 GLHP = Ground Loop Heat Pump

## AHRI/ISO 13256-2 Performance Ratings

English (IP) Units

Model	Flow Rate		Water Loop Heat Pump				Ground Water Heat Pump				Ground Loop Heat Pump			
			Cooling 86°F Source 53.6°F Load		Heating 68°F Source 104°F Load		Cooling 59°F Source 53.6°F Load		Heating 50°F Source 104°F Load		Cooling 77°F Source 53.6°F Load		Heating 32°F Source 104°F Load	
	Load GPM	Source GPM	Capacity Btuh	EER Btuh/W	Capacity Btuh	COP	Capacity Btuh	EER Btuh/W	Capacity Btuh	COP	Capacity Btuh	EER Btuh/W	Capacity Btuh	COP
<b>040</b>	10	10	29,100	13.4	43,500	4.6	33,000	20.1	40,000	4.0	30,600	16.1	34,000	3.3
<b>050</b>	15	15	41,500	13.3	66,000	4.7	47,000	20.1	54,900	3.9	44,500	16.1	45,000	3.3
<b>066</b>	20	20	52,000	12.7	83,000	4.4	57,000	20.1	70,000	3.7	54,000	16.1	56,500	3.2

7/8/14



All 5 Series products are safety listed under UL1995 thru ETL and performance listed with AHRI in accordance with standard 13256-2. The 5 Series is also ENERGY STAR® rated.



## 5 Series with OptiHeat

### Unit Features

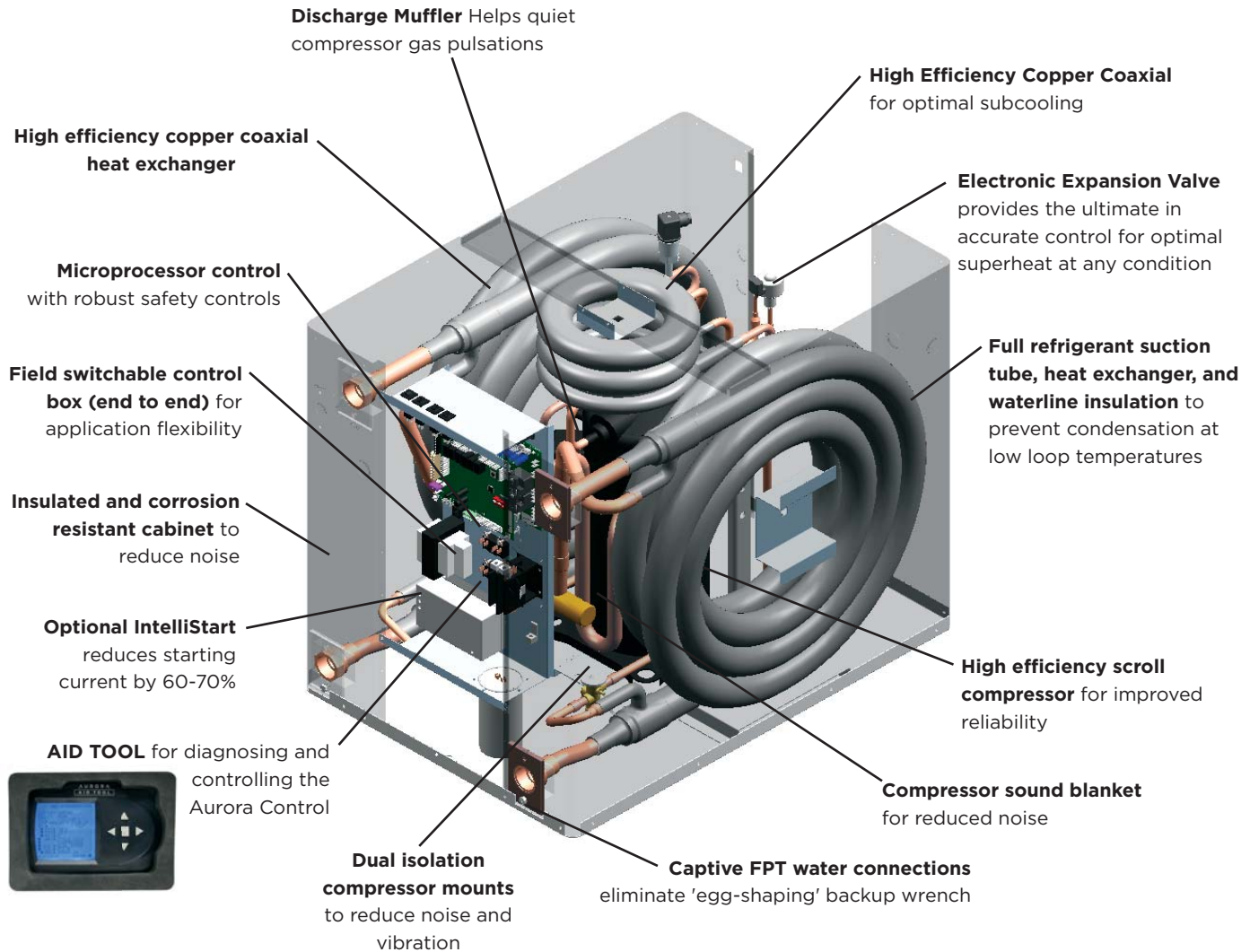

### What's New

- **Advanced Service Features**

- Aurora can be internet capable simply by adding the Aurora WebLink (AWL). This device will connect your Aurora system to web for remote monitoring and control. It also comes standard with an SD drive for storing operating and performance data. Providing 'black box' capability.

- **Monitoring Sensor Kits**

- *Energy Monitoring:* With this standard sensor kit, the Aurora Advanced Control will feature power monitoring of the compressor, load pump and electric heat; the information can be displayed on AID Tool, or through AWL
- *Performance/Refrigerant Monitoring:* The OptiHeat features refrigeration and performance sensors as an optional feature; now refrigerant pressures, and various temperatures needed to diagnose unit problems are readily available at your fingertips in the AID Tool. The Aurora controls can measure actual capacity and efficiency performance of the heat pump; the information can be displayed on AID Tool or thru AWL to Symphony.



## 5 Series OptiHeat cont.

### Operating Efficiencies

- Environmentally friendly R-410A refrigerant reduces ozone depletion.
- High-stability bidirectional expansion valve provides superior performance.
- Efficient scroll compressor operates quietly.
- Oversized coaxial tube water-to-refrigerant heat exchanger increases efficiency.
- Electronic expansion valve for VI circuits

### Standard Features

- Heavy gauge cabinet
- Quiet scroll compressors in all models
- All interior cabinet surfaces are insulated with ½ in. [12.7 mm] thick 1 ½ lb. [681 g] density, surface coated, acoustic type glass fiber insulation.
- Optional IntelliStart® to reduce starting current (208-230/60/1) (O40 only)
- Field switchable control box - Control box factory installed on water line side of cabinet
- Ultra-compact cabinet
- Multi-density laminate lined compressor blanket designed to suppress low frequency noise.
- Discharge line mufflers to help quiet compressor discharge gas pulsations.
- Removable compressor access panels.
- Quick attach wiring harnesses are used throughout for fast servicing.
- High and low pressure refrigerant service ports.
- Two removable access panels

### Product Quality

- Heavy-gauge steel cabinets are finished with a durable polyester powder coat paint for long lasting beauty and service.
- All refrigerant brazing is performed in a nitrogen atmosphere.
- Coaxial heat exchangers, refrigerant suction lines and all water pipes are fully insulated to reduce condensation problems in low temperature operation.
- Computer controlled deep vacuum and refrigerant charging system.
- All joints are leak detected for maximum leak rate of less than ¼ oz. per year.
- Computer bar code equipped assembly line ensures all components are correct.
- All units are computer run-tested with water to verify both function and performance.
- Safety features include high- and low-pressure refrigerant controls to protect the compressor.

### Options and Accessories

- Closed loop, source side, circulating pump kit
- Closed loop, load side, circulating pump kit
- Water connection kits
- Geo-Storage Tank (80-119 Gal. capacity)
- IntelliStart
- HydroZone, tank control with outdoor reset
- HydroStat, Communicating Set Point Control, Symphony (AWL) Compatible
- Hydrologic

### Application Flexibility

- Designed to operate with entering source temperature of 30°F and leaving load temperatures of up to 150°F. See the capacity tables to see allowable operating conditions per model.
- Source side flow rates as low as 1.5 GPM/ton for well water, 50°F [10°C] min. EWT.
- Dedicated heating and heat pump models available.
- Dedicated non-reversible models are shipped as heating only.
- Compact size allows installation in confined spaces.
- Front or rear plumbing connections.

## Inside the 5 Series OptiHeat

### Refrigerant

OptiHeat products all feature zero ozone depletion and low global warming potential R-410A refrigerant.

### Cabinet

All units are constructed of corrosion resistant galvanized sheet metal with powder coat paint rated for more than 1000 hours of salt spray. Lift-out access panels provide access to the compressor section from two sides.

### Compressor

High efficiency R-410A vapor injected, scroll compressors for each model sizes provides efficient yet reliable operation at all operating conditions.

### Electrical Box

The control panel is "field" movable from front to back for ease of application. Separate knockouts for low voltage, and two for power on, front and back, allow easy access to the control box. Large 75VA transformer assures adequate controls power for accessories.

### Water Connections

Flush mount FPT water connection fittings allow one wrench leak-free connections and do not require a backup wrench. Factory installed water line thermistors can be viewed through the microprocessor interface tool.

### Thermostatic Expansion Valve

All OptiHeat models utilize a balanced port bidirectional thermostatic expansion valve (TXV) for refrigerant metering. This allows precise refrigerant flow in a wide range of entering water variation (30 to 150°F [-1 to 65°C]) found in geothermal systems. The TXV is located in the compressor compartment for easy access.



### Water-to-Refrigerant Heat Exchanger Coil

Large oversized coaxial refrigerant-to-water heat exchangers provide unparalleled efficiency. The coaxes are designed for low pressure drop and low flow rates. All coaxes are pressure rated to 450 psi water side and 650 psi on the refrigerant side. Refrigerant-to-water heat exchangers will be coated with ThermaShield to prevent condensation in low temperature loop operation.



### Service Connections and Serviceability

Two Schrader service ports are provided for each unit. The suction side and discharge side ports are for field charging and servicing access. All valves are 7/16 in. SAE connections.



### 4-Way Reversing Valve

OptiHeat units feature a reliable all-brass pilot operated refrigerant reversing valve. The reversing valve operation is limited to change of mode by the control to enhance reliability.



### IntelliStart (040 only)

The optional IntelliStart single phase soft starter will reduce the normal start current (LRA) by 60-70%. This allows the heat pump to go off-grid. Using IntelliStart also provides a substantial reduction in light flicker, reduces start-up noise, and improves the compressor's start behavior. IntelliStart is available in a field retrofit kit or as a factory installed option.



# Water Quality

## General

Water-to-water heat pumps may be successfully applied in a wide range of residential and light commercial applications. It is the responsibility of the system designer and installing contractor to ensure that acceptable water quality is present and that all applicable codes have been met in these installations. Failure to adhere to the guidelines in the water quality table could result in loss of warranty.

## Application

These heat pumps are not intended for direct coupling to swimming pools and spas. If used for this type of application, a secondary heat exchanger must be used. Failure to supply a secondary heat exchanger for this application will result in warranty exclusion for primary heat exchanger corrosion or failure.

## Water Treatment

The use of improperly treated or untreated water in this equipment may result in scaling, erosion, corrosion, algae or slime. The services of a qualified water treatment specialist should be engaged to determine what treatment, if any, is required. The product warranty specifically excludes liability for corrosion, erosion or deterioration of equipment.

The heat exchangers and water lines in the units are copper tube. There may be other materials in the building's piping system that the designer may need to take into consideration when deciding the parameters of the water quality.

If an antifreeze or water treatment solution is to be used, the designer should confirm it does not have a detrimental effect on the materials in the system.

## Contaminated Water

In applications where the water quality cannot be held to prescribed limits, the use of a secondary or intermediate heat exchanger is recommended to separate the unit from the contaminated water.

The following table outlines the water quality guidelines for unit heat exchangers. If these conditions are exceeded, a secondary heat exchanger is required. Failure to supply a secondary heat exchanger where needed will result in a warranty exclusion for primary heat exchanger corrosion or failure.



**WARNING:** Must have intermediate heat exchanger when used in pool and spa applications.

## Water Quality Guidelines

Material		Copper	90/10 Cupronickel	316 Stainless Steel
pH	Acidity/Alkalinity	7 - 9	7 - 9	7 - 9
Scaling	Calcium and Magnesium Carbonate	(Total Hardness) less than 350 ppm	(Total Hardness) less than 350 ppm	(Total Hardness) less than 350 ppm
	Hydrogen Sulfide	Less than 0.5 ppm (rotten egg smell appears at 0.5 ppm)	10 - 50 ppm	Less than 1 ppm
Corrosion	Sulfates	Less than 125 ppm	Less than 125 ppm	Less than 200 ppm
	Chlorine	Less than 0.5 ppm	Less than 0.5 ppm	Less than 0.5 ppm
	Chlorides	Less than 20 ppm	Less than 125 ppm	Less than 300 ppm
	Carbon Dioxide	Less than 50 ppm	10 - 50 ppm	10 - 50 ppm
	Ammonia	Less than 2 ppm	Less than 2 ppm	Less than 20 ppm
	Ammonia Chloride	Less than 0.5 ppm	Less than 0.5 ppm	Less than 0.5 ppm
	Ammonia Nitrate	Less than 0.5 ppm	Less than 0.5 ppm	Less than 0.5 ppm
	Ammonia Hydroxide	Less than 0.5 ppm	Less than 0.5 ppm	Less than 0.5 ppm
	Ammonia Sulfate	Less than 0.5 ppm	Less than 0.5 ppm	Less than 0.5 ppm
	Total Dissolved Solids (TDS)	Less than 1000 ppm	1000 - 1500 ppm	1000 - 1500 ppm
LSI Index	+0.5 to -0.5	+0.5 to -0.5	+0.5 to -0.5	
Iron Fouling (Biological Growth)	Iron, FE <sup>2+</sup> (Ferrous) Bacterial Iron Potential	< 0.2 ppm	< 0.2 ppm	< 0.2 ppm
	Iron Oxide	Less than 1 ppm, above this level deposition will occur	Less than 1 ppm, above this level deposition will occur	Less than 1 ppm, above this level deposition will occur
Erosion	Suspended Solids	Less than 10 ppm and filtered for max. of 600 micron size	Less than 10 ppm and filtered for max. of 600 micron size	Less than 10 ppm and filtered for max. of 600 micron size
	Threshold Velocity (Fresh Water)	< 6 ft/sec	< 6 ft/sec	< 6 ft/sec

NOTES: Grains = ppm divided by 17  
mg/L is equivalent to ppm

7/08/14

# The Aurora™ Control System

## Aurora ‘Base’ Control

The Aurora ‘Base’ Control (ABC) System is a complete residential and commercial comfort system that brings all aspects of the HVAC system into one cohesive module network. The ABC features microprocessor control and HP, LP, freeze detection, over/under voltage faults.

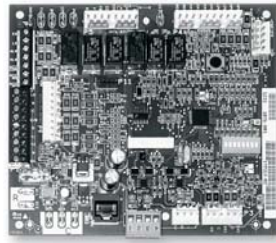

Aurora uses the Modbus communication protocol to communicate between modules. Each module contains the logic to control all features that are connected to the module. The Aurora ‘Base’ Control (ABC) has two Modbus channels for connecting the Aurora Interface Diagnostics Tool (AID Tool).

## Aurora ‘Advanced’ Control

The Aurora ‘Advanced’ Control expands on the capability of the Aurora ‘Base’ Control (ABC) System by adding the Aurora Expansion Board (AXB). The additional features include loop pump linking and variable speed pump capability. The AXB also features a second field configurable accessory relay, and two home automation inputs that are AID configurable for different types of alarms from sump pumps to home security. The Smart Grid input is AID configurable with many options to react to Utility controlled relay operation for ON Peak optimization.

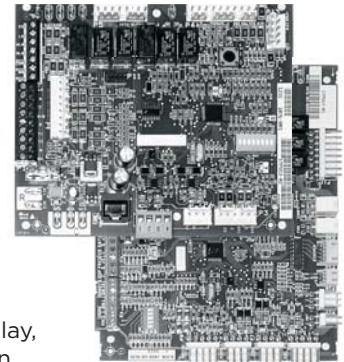

Aurora Control Features	Description	Aurora ‘Advanced’
<b>Microprocessor Compressor Control</b>	Microprocessor control of compressor for timings with FP1, HP, LP, Condensate, assignable Acc relay	•
<b>Advanced Microprocessor Features</b>	Smart Grid, Home Automation Alarm Inputs, and Accessory2 Relay (HRV/ERV)	•
<b>Advanced Speed Pump Control</b>	Microprocessor and separate power relay for loop pump and inline circuit breakers and loop pump linking.	•
<b>Variable Speed Pump</b>	Capable of setup, monitoring and controlling a variable speed flow center.	•
<b>Smart Grid/Utility Input</b>	Allows simple input to externally enable of occupied/unoccupied mode for basic utility time of use programs.	Dry Contact x1
<b>Home Automation Alarm Input</b>	Allows simple input to signal sump, security, or smoke/CO sensor alarms from other home automation or security systems. The two inputs can be field configured to a number of options and logic.	Dry Contactx2
<b>HAN/Smart Grid Com (AWL and Portal) Kit</b>	Allows direct communication of the Aurora to Smart Meters, Home Automation Network and Internet.	Optional AWL

Service Device	Description	Aurora ‘Advanced’
 <b>Aurora Interface and Diagnostics (AID) Tool</b>	Allows setup, monitoring and troubleshooting of any Aurora Control.  <b>NOTE:</b> Although the ABC has basic compatibility with all Aurora, new product features may not be available on older AID Tools. To simplify the basic compatibility ensure the version of AID is at least the same or greater than the ABC software version.	For Service (Ver. 2.xx or greater)

## The Aurora™ Control System cont.

Add On Control Feature Kits (field or factory installed)	Description	Aurora 'Advanced'
<b>Geo Energy Monitoring Kit</b>	Monitors realtime power consumption of compressor, aux heat and pump. AXB required.	Standard
<b>Performance &amp; Refrigeration Monitoring Kit</b>	Monitors real time refrigerant temperatures, pressures & water temperatures. For subcooling & calculates the heat of extraction/rejection.	Optional Sensor Kit
<b>Data Logging (AWL) Kit</b>	Allows data logging of up to 12 months. AXB required. Can also be temporarily installed for troubleshooting.	Optional
<b>HAN/Smart Grid Com (AWL and Portal) Kit</b>	Allows direct communication of the Aurora to Smart Meters, HAN, and internet. AXB required.	Optional

Add On Thermostats and Zoning	Description	Aurora 'Advanced'	Symphony Compatible
<b>HSC - HydroStat</b>	Communicating tank controller for one hydronic heat pump.	Optional	Yes
<b>HZO</b>	Non-communicating tank controller for up to four heat pumps.	Optional	No
<b>HZC</b>	Non-communicating tank controller for one hydronic heat pump	Optional	No
<b>HydroLogic</b>	4 zone expandable to 8 zones	Optional	No

## The Aurora™ Control System cont.

### Aurora 'Base' Control

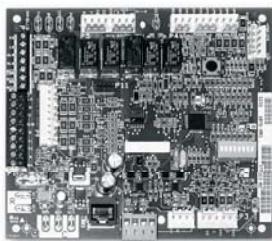

**NOTE:** Refer to the Aurora Base Control Application and Troubleshooting Guide and the Instruction Guide: Aurora Interface and Diagnostics (AID) Tool for additional information.

### Control Features

- Random start at power up
- Anti-short cycle protection
- High and low pressure cutouts
- Loss of charge
- Water coil freeze detection
- Over/under voltage protection
- Load shed
- Emergency shutdown
- Diagnostic LED
- Test mode push button switch
- Alarm output
- Accessory output with N.O. and N.C.
- Two Modbus communication ports

### Field Selectable Options via Hardware

**DIP Switch (SW1)** – Test/Configuration Button (See SW1 Operation Table)

#### Test Mode

The control is placed in the test mode by holding the push button switch SW1 for 2 - 5 seconds. In test mode most of the control timings will be shortened by a factor of sixteen (16). LED3 (green) will flash at 1 second on and 1 second off. Additionally, when entering test mode LED1 (red) will flash the last lockout one time. Test mode will automatically time out after 30 minutes. Test mode can be exited by pressing and holding the SW1 button for 2 to 5 seconds or by cycling the power. **NOTE:** Test mode will automatically be exited after 30 minutes.

#### Reset Configuration Mode

The control is placed in reset configuration mode by holding the push button switch SW1 for 50 to 60 seconds. This will reset all configuration settings and the EEPROM back to the factory default settings. LED3 (green) will turn off when entering reset configuration mode. Once LED3 (green) turns off, release SW1 and the control will reset.

### DIP Switch (SW2)

**SW2-1 (Source)** FP1 Selection – Low water coil temperature limit setting for freeze detection. On = 30°F; Off = 15°F.

**SW2-2 (Load)** FP2 Selection – On = 30°F; Off = 15°F

**SW2-3** RV – O/B - thermostat type. Heat pump thermostats with “O” output in cooling or “B” output in Heating can be selected. On = O; Off = B.

**SW2-4** Access Relay Operation (P2)  
**and 2-5**

Access Relay Operation	SW2-4	SW2-5
Cycle with Blower		n/a
Cycle with Compressor	OFF	OFF
Water Valve Slow Opening	ON	OFF
Cycle with Comm. T-stat Hum Cmd		n/a

**Cycle with Blower** - (Not used on water-to-water)

**Cycle with Compressor** - The accessory relay will cycle with the compressor output.

**Water Valve Slow Opening** - The accessory relay will cycle and delay both the blower and compressor output for 90 seconds.

**SW2-6** CC Operation – selection of single or dual capacity compressor. On = Single Stage; Off = Dual Capacity

**SW2-7** Lockout and Alarm Outputs (P2) – selection of a continuous or pulsed output for both the LO and ALM Outputs. On = Continuous; Off = Pulsed

**SW2-8** *Future Use*

### Alarm Jumper Clip Selection

From the factory, ALM is connected to 24 VAC via JW2. By cutting JW2, ALM becomes a dry contact connected to ALG.

### Field Selectable Options via Software

(Selectable via the Aurora AID Tool)

### Safety Features

The following safety features are provided to protect the compressor, heat exchangers, wiring and other components from damage caused by operation outside of design conditions.

**Fuse** – a 3 amp automotive type plug-in fuse provides protection against short circuit or overload conditions.

**Anti-Short Cycle Protection** – 4 minute anti-short cycle protection for the compressor.

**Random Start** – 5 to 80 second random start upon power up.



## The Aurora™ Control System cont.

**Fault Retry** - In the fault condition, the control will stage off the outputs and then “try again” to satisfy the thermostat Y input call. Once the thermostat input calls are satisfied, the control will continue on as if no fault occurred. If 3 consecutive faults occur without satisfying the thermostat Y input call, then the control will go to Lockout mode.

**Lockout** - The Alarm output (ALM) and Lockout output (L) will be turned on. The fault type identification display LED1 (Red) shall flash the fault code. To reset lockout conditions with SW2-8 On, thermostat inputs “Y1”, “Y2”, and “W” must be removed for at least 3 seconds. To reset lockout conditions with SW2-8 Off, thermostat inputs “Y1”, “Y2”, “W”, and “DH” must be removed for at least 3 seconds. Lockout may also be reset by turning power off for at least 30 seconds or by enabling the emergency shutdown input for at least 3 seconds.

**High Pressure** - fault is recognized when the Normally Closed High Pressure Switch, P4-9/10 opens, no matter how momentarily. The High Pressure Switch is electrically in series with the Compressor Contactor and serves as a hard-wired limit switch if an overpressure condition should occur.

**Low Pressure** - fault is recognized when the Normally Closed Low Pressure Switch, P4-7/8 is continuously open for 30 seconds. Closure of the LPS any time during the 30 second recognition time restarts the 30 second continuous open requirement. A continuously open LPS shall not be recognized during the 2 minute startup bypass time.

**Loss of Charge** - fault is recognized when the Normally Closed Low Pressure Switch, P4-7/8 is open prior to the compressor starting.

**Freeze Detection (Source Coax)** - set points shall be either 30°F or 15°F. When the thermistor temperature drops below the selected set point, the control shall begin counting down the 30 seconds delay. If the thermistor value rises above the selected set point, then the count should reset. The resistance value must remain below the selected set point for the entire length of the appropriate delay to be recognized as a fault. This fault will be ignored for the initial 2 minutes of the compressor run time.

**Freeze Detection (Load Coax)** - uses the FP2 input to protect against ice formation on the coax. The FP2 input will operate exactly like FP1.

**Over/Under Voltage Shutdown** - An over/under voltage condition exists when the control voltage is outside the range of 18 VAC to 30 VAC. If the over/under voltage shutdown lasts for 15 minutes, the lockout and alarm relay will be energized. Over/under voltage shutdown is self-resetting in that if the voltage comes back within range of 18 VAC to 30 VAC for at least 0.5 seconds, then normal operation is restored.

### Operation Description

**Power Up** - The unit will not operate until all the inputs and safety controls are checked for normal conditions. The unit has a 5 to 80 second random start delay at power up. Then the compressor has a 4 minute anti-short cycle delay after the random start delay.

**Standby** In standby mode, Y1, Y2, W, DH, and G are not active. Input O may be active. The blower and compressor will be off.

### Heating Operation

**Heating, 1st Stage (Y1)** - The compressor is energized 10 seconds after the Y1 input is received.

### Cooling Operation

In all cooling operations, the reversing valve directly tracks the O input. Thus, anytime the O input is present, the reversing valve will be energized.

**Cooling, 1st Stage (Y1, O)** - The compressor is energized 10 seconds after the Y1 input is received.

**Emergency Shutdown** - Four (4) seconds after a valid ES input, P2-7 is present, all control outputs will be turned off and remain off until the emergency shutdown input is no longer present. The first time that the compressor is started after the control exits the emergency shutdown mode, there will be an anti-short cycle delay followed by a random start delay. Input must be tied to common to activate.

**Load Shed** - The LS input disables all outputs from the ABC control board. When the LS input has been cleared, the anti-short cycle timer and random start timer will be initiated. Input must be tied to common to activate.



# The Aurora™ Control System cont.

## Aurora ‘Base’ Control LED Displays

These three LEDs display the status, configuration, and fault codes for the control. These can also be read in plain English via the Aurora AID Tool.

### Status LED (LED3, Green)

Description of Operation	Fault LED, Green
Normal Mode	ON
Control is Non-functional	OFF
Test Mode	Slow Flash
Lockout Active	Fast Flash
Dehumidification Mode	Flash Code 2
(Future Use)	Flash Code 3
(Future Use)	Flash Code 4
Load Shed	Flash Code 5
Emergency Shut Down	Flash Code 6
On Peak Mode	Flash Code 7

## Aurora Interface and Diagnostics (AID) Tool

The Aurora Interface and Diagnostics (AID) Tool is a device that is a member of the Aurora network. The AID Tool is used to troubleshoot equipment which uses the Aurora control via Modbus RTU communication. The AID Tool provides diagnostics, fault management, ECM setup, and system configuration capabilities to the Aurora family of controls. An AID Tool is recommended, although not required, for ECM airflow settings. The AID Tool simply plugs into the exterior of the cabinet in the AID Tool port.



## ABC Control Board Layout

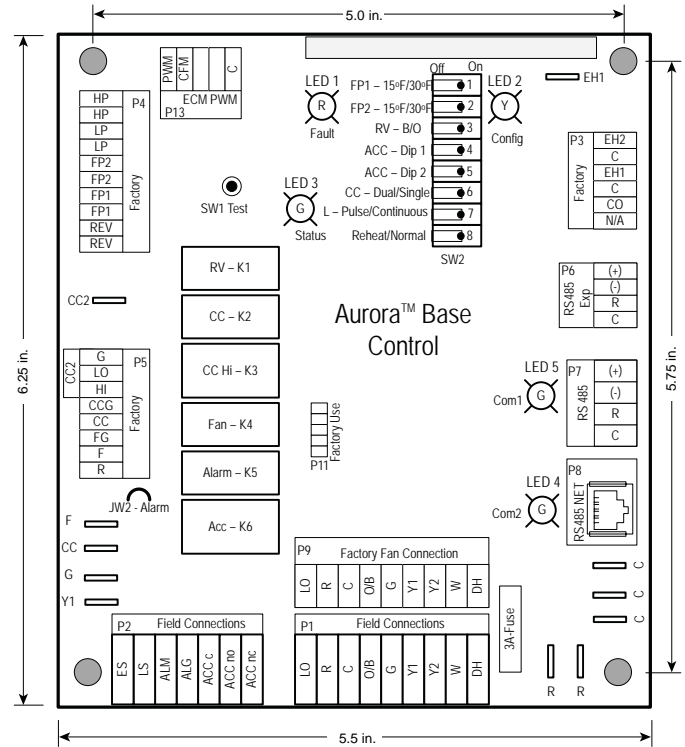

## The Aurora™ Control System cont.

### Aurora 'Advanced' Control Features

The Aurora 'Advanced' Control system expands on the capability of the Aurora 'Base' Control (ABC) by adding the Aurora Expansion Board (AXB). All of the preceding features of the Aurora 'Base' Control are included. The following control description is of the additional features and capability of the Aurora advanced control.

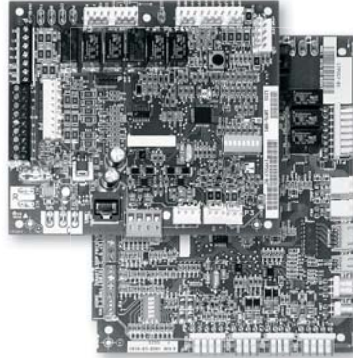

It is highly recommended the installing/servicing contractor obtain an Aurora Interface and Diagnostic Tool (AID) and specialized training before attempting to install or service an Aurora 'Advanced' control system.



The additional AXB features include the following:

#### AXB DIP Switch

**DIP 1 - ID:** This is the AXB ModBus ID and should always read On.

#### DIP 2 & 3 - Future Use

**DIP 4 & 5 - Accessory Relay2:** A second, DIP configurable, accessory relay is provided that can be cycled with the compressor 1 or 2, blower, or the Dehumidifier (DH) input. This is to complement the Accessory 1 Relay on the ABC board.

Position	DIP 4	DIP 5	Description
1	ON	ON	Cycles with Fan or ECM (or G)
2	OFF	ON	Cycles with CC1 first stage of compressor or compressor spd 1-12
3	ON	OFF	Cycles with CC2 second stage of compressor or compressor spd 7-12
4	OFF	OFF	Cycles with DH input from ABC board

#### Variable Speed Pump

This input and output are provided to drive and monitor a variable speed pump. The VS pump output is a PWM signal to drive the variable speed pump. The minimum and maximum level are set using the AID Tool. 75% and 100% are the default settings respectively. The VS data input allows a separate PWM signal to return from the pump giving fault and performance information. Fault received from the variable speed pump will be displayed as E16. With single speed equipment both min & max should be set to the same value.

#### Modulating Water Valve

This output is provided to drive a modulating water valve. Through advanced design the 0-10VDC valve can be driven directly from the VS pump output. The minimum and maximum level are set in the same way as the VS pump using the AID Tool. 75% and 100% are the default settings respectively. With single speed equipment both min & max should be set to the same value.

#### Compressor Monitoring

The AXB includes two current transducers to monitor the compressor current and starting characteristics. Open circuits or welded contactor faults will be detected. A fault will produce an E10 code.

If the E10 fault code is due to the thermal overload on the compressor being tripped. Ensure adequate water flow on both the load and source side of the unit and review the unit operating envelope. If the unit is operating in the "Sensitive Operating Range", as shown in the OptiHeat Installation Manual, you may need to adjust the leaving load temperatures.

#### Loop Pump Linking

This input and output are provided so that two units can be linked together with a common flow center. When either unit has a call for loop pump, both unit's loop pump relays and variable speed pumps are energized. The flow center then can simply be wired to either unit. The output from one unit should be routed to the input of the other. If daisy chained up to 16 heat pumps can be wired and linked together in this fashion.

#### Advanced Communication Ports

Communication ports P6 and P8 will provide future expansion via dedicated protocols. These are for future use.

#### Smart Grid-On Peak (SG) Input

The 'On Peak' input was designed to allow utilities to utilize simple radio controlled switches to control the On Electric Peak behavior of the 5 and 7 Series Geothermal Heat Pumps. With a closed contact signal, this input will limit the operation and thus the power consumption of the unit by one of the below selections. The AID Tool will allow configuration of this input for the action of:

- No Action
- Disable compressor operation until removed
- Go to On Peak thermostat settings until removed [Requires Com T-Stat] (Future Release)
- Compressor limited to 50% or low cap until removed [dual capacity or variable speed only] (Future Release)
- Disable compressor operation for 1/2 hr (can be removed immediately) (Future Release)

Then Flash Code 7 on the Green LED for the 'On Peak' mode. And On Peak will display on communicating thermostats.

## The Aurora™ Control System cont.

### Home Automation 1 and 2 Inputs

The Home automation inputs are simple closed contact inputs that will trigger an AID Tool and thermostat alert for the homeowner. These would require optional sensors and or equipment for connection to the AXB board. With two inputs two different sensors can be selected. The selected text will then be displayed on the AID Tool and communicating thermostats. These events will NOT alter functionality or operation of the heat pump/accessories and is for homeowner/service notification only.

#### Home Automation 1 - E23 HA1

With a closed dry contact signal, this input will cause an alarm and Alert Code 23 to indicate on the stat or flash on ABC. The AID Tool will allow configuration of this input between the following selections:

- No Action
- Home Automation Fault [no lockout info only]
  - Output from home automation system
- Security Alarm [no lockout info only]
  - Output from home security
- Sump Alarm Fault [no lockout info only]
  - Switch output from sump sensor
- Smoke/CO Alarm Fault [no lockout info only]
  - Switch output from Smoke/CO sensor
- Dirty Filter Alarm [no lockout info only]
  - Output from dirty filter sensor

#### Home Automation 2 - E24 HA2

With a closed dry contact signal, this input will cause an alarm and Alert Code 24 to indicate on the stat or flash on ABC. The AID Tool will allow configuration of this input between the following selections:

- No Action
- Home Automation Fault [no lockout info only]
  - Output from home automation system
- Security Alarm [no lockout info only]
  - Output from home security
- Sump Alarm Fault [no lockout info only]
  - Switch output from sump sensor
- Smoke/CO Alarm Fault [no lockout info only]
  - Switch output from Smoke/CO sensor
- Dirty Filter Alarm [no lockout info only]
  - Output from dirty filter sensor

### Monitoring Sensor Kits

#### Energy monitoring (Standard Sensor Kit)

The Energy Monitoring Kit includes two current transducers (load pump and electric heat) added to the existing two compressor sensors so that the complete power usage of the heat pump can be measured. The AID Tool provides a line voltage calibration procedure to improve the accuracy, and a power adjustment setting that allows the compressor power to be adjusted to match the units line voltage using the provided tables. This information can be displayed on the AID Tool or Symphony via AWL.

#### Performance and Refrigeration Monitoring (optional sensor kit)

The optional Performance and Refrigeration Monitoring Kits includes a pressure sensor, temperature sensors, and a source side water flow rate sensor. The temperature sensors monitor entering and leaving source, leaving load water, heating liquid line and existing cooling liquid line (FPI). The pressure sensor monitors the system's discharge pressure. With this kit, heat of extraction and rejection will be calculated. This requires configuration using the AID Tool for selection of water or antifreeze. These sensors also allow for the subcooling to be displayed on the AID Tool or Symphony via AWL. **NOTE: Superheat displayed on the AID Tool is not true superheat, it is the superheat of the vapor injection circuit.**

**Power Adjustment Table**

Model	Voltage		
	208V	230V	250V
040	.96	.89	.77
050	.96	.89	.77
060	.96	.89	.77

## The Aurora™ Control System cont.

### Aurora 'Advanced' Control LED Displays

These three LEDs display the status, configuration, and fault codes for the control. These can also be read in plain English via the Aurora AID Tool.

#### Status LED (LED3, Green)

Description of Operation	Fault LED, Green
Normal Mode	ON
Control is Non-functional	OFF
Test Mode	Slow Flash
Lockout Active	Fast Flash
Dehumidification Mode	Flash Code 2
Load Shed	Flash Code 5
Emergency Shutdown	Flash Code 6
On Peak Mode	Flash Code 7
(Future Use)	Flash Code 8
(Future Use)	Flash Code 9

#### Fault LED (LED1, Red)

Red Fault LED	LED Flash Code *	Lockout	Reset/Remove	Fault Condition Summary	
Normal - No Faults	Off	-			
ABC Basic Faults	Fault-Input	1	No	Auto	Tstat input error. Autoreset upon condition removal.
	Fault-High Pressure	2	Yes	Hard or Soft	HP switch has tripped (>650 psi)
	Fault-Low Pressure	3	Yes	Hard or Soft	Low Pressure Switch has tripped (<40 psi for 30 continuous sec.)
	Fault-Freeze Detection FP2	4	Yes	Hard or Soft	Freeze protection sensor has tripped (<15 or 30 degF for 30 continuous sec.)
	Fault-Freeze Detection FP1	5	Yes	Hard or Soft	Freeze protection sensor has tripped (<15 or 30 degF for 30 continuous sec.)
	Fault-Condensate Overflow	7	Yes	Hard or Soft	Condensate switch has shown continuity for 30 continuous sec.
	Fault-Over/Under Voltage	8	No	Auto	Instantaneous voltage is out of range. **Controls shut down until resolved.
	Fault-FP1 Snsr Error	11	Yes	Hard or Soft	If FP1 Sensor Error
ABC & AXB Advanced Faults	Fault-Compressor Monitor	10	Yes	Hard or Soft	Open Crkt, Run, Start or welded cont, Comp operation in sensitive operating range
	Non-CriticAXBSnsrErr	13	No	Auto	Any Other Sensor Error
	CriticAXBSnsrErr	14	Yes	Hard or Soft	Sensor Error for EEV or HW
	Alert-HotWtr	15	No	Auto	HW over limit or logic lockout. HW pump deactivated.
	Fault-VarSpdPump	16	No	Auto	Alert is read from PWM feedback.
	Not Used	17	No	Auto	IZ2 Com Fault. Autoreset upon condition removal.
	Non-CritComErr	18	No	Auto	Any non-critical com error
	Fault-CritComErr	19	No	Auto	Any critical com error. Auto reset upon condition removal
	Alarm - Low Loop Pressure	21	No	Auto	Loop pressure is below 3 psi for more than 3 minutes
	Alarm - Home Automation 1	23	No	Auto	Closed contact input is present on Dig 2 input - Text is configurable
Alarm - Home Automation 2	24	No	Auto	Closed contact input is present on Dig 3 input - Text is configurable	

#### NOTES:

\*All codes >11 use long flash for tens digit and short flash for the ones digit. 20, 30, 40, 50 etc. are skipped!

Alert' is a noncritical sensor or function that has failed. Normal operation of the heat pump is maintained but service is desired at some point.

## Application Notes

### The Closed Loop Heat Pump Concept

The basic principle of a water source heat pump is the transfer of heat into water from the space during cooling, or the transfer of heat from water into the space during heating. Extremely high levels of energy efficiency are achieved as electricity is used only to move heat, not to produce it. Using our typical water-to-water heat pump one unit of electricity will move four to five units of heat.

When multiple water source heat pumps are combined on a common circulating loop, the ultimate in energy efficiency is created: The water-to-water units on cooling mode are adding heat to the loop which the units in heating mode can absorb, thus removing heat from the area where cooling is needed, recovering and redistributing that heat for possible utilization elsewhere in the system. In modern commercial structures, this characteristic of heat recovery from core area heat generated by lighting, office equipment, computers, solar radiation, people or other sources, is an important factor in the high efficiency and low operating costs of our closed source heat pump systems.

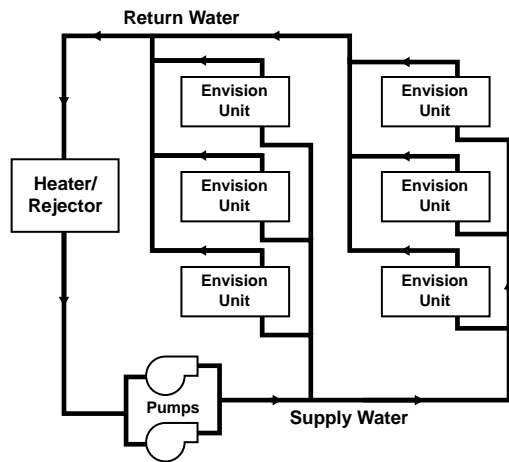

In the event that a building's net heating and cooling requirements create loop temperature extremes, our units have the extended range capacity and versatility to maintain a comfortable environment for all building areas. Excess heat can be stored for later utilization or be added or removed in one of three ways; by ground-source heat exchanger loops: plate heat exchangers connected to other water sources, or conventional cooler/boiler configurations. Your sales representative has the expertise and computer software to assist in determining optimum system type for specific applications.

### The Closed Loop Advantage

A properly applied water source heat pump system offers many advantages over other systems. First costs are

low because units can be added to the loop on an "as needed basis"- perfect for speculative buildings. Installed costs are low since units are self-contained and can be located adjacent to the occupied space, requiring minimal ductwork. Maintenance can be done on individual units without system shut-down. Conditions remain comfortable since each unit operates separately, allowing cooling in one area and heating in another. Tenant spaces can be finished and added as needed. Power billing to tenants is also convenient since each unit can be individually metered: each pays for what each uses. Nighttime and/or weekend uses of certain areas are possible without heating or cooling the entire facility. A decentralized system also means if one unit should fault, the rest of the system will continue to operate normally, as well as eliminating air cross-contamination problems and expensive high pressure duct systems requiring an inefficient electric resistance reheat mode.

### The Best Approach

There are a number of proven choices in the type of system which would be best for any given application. Most often considered are:

#### Vertical - Closed Loop/Ground Source



• **Closed Loop/Ground-Source Systems** utilize the stable temperatures of the earth to maintain proper water source temperatures (via vertical or horizontal closed loop heat exchangers) for our extended range heat pump system. Sizes range from a single unit through many hundreds of units. When net cooling requirements cause closed loop water temperatures to rise, heat is dissipated into the cooler earth through buried high strength plastic pipe "heat exchangers." Conversely if net space heating demands cause loop heat absorption beyond that heat recovered from building core areas, the loop temperature will fall causing heat to be extracted from the earth. Due to the extended loop temperatures, AHRI/ISO 13256-1 Ground Loop Heat Pumps are required for this application.



## Application Notes cont.

Because auxiliary equipment such as a fossil fuel boiler and cooling tower are not required to maintain the loop temperature, operating and maintenance costs are very low. Ground-source systems are most applicable in residential and light commercial buildings where both heating and cooling are desired, and on larger envelope dominated structures where core heat recovery will not meet overall heating loads. Both vertical and horizontally installed closed-loops can be used. The land space required for the "heat exchangers" is 100-250 sq. ft./ton on vertical (drilled) installations and 750-1500 sq. ft./ton for horizontal (trenched) installations. Closed loop heat exchangers can be located under parking areas or even under the building itself.

On large multi-unit systems, sizing the closed loop heat exchanger to meet only the net heating loads and assisting in the summer with a closed circuit cooling tower may be the most cost effective choice.

### **Surface Water - Closed Loop/Ground Source**



• **Closed Loop/Ground-Source Surface Water Systems** also utilize the stable temperatures of Surface Water to maintain proper water source temperatures for our extended range heat pump systems. These systems have all of the advantages of horizontal and vertical closed loop systems. Due to the extended loop temperatures, AHRI/ISO 13256-1 Ground Water or Ground Loop Heat Pumps are required for this application.

In cooling dominated structures, the ground-source surface water systems can be very cost effective especially where local building codes require water retention ponds for short term storage of surface run-off. Sizing requirements for the surface water is a minimum of 500 sq. ft./ton of surface area at a minimum depth of 8 feet. Your sales representative should be contacted when designs for heating dominated structures are required.

### **Plate Heat Exchanger - Closed Loop/Ground Water**

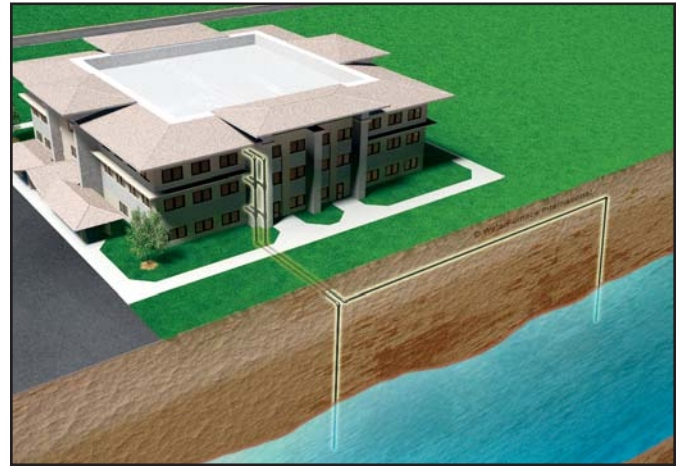

• **Closed Loop/Ground Water Plate Heat Exchanger Systems** utilize lake, ocean, well water or other water sources to maintain closed loop water temperatures in multi-unit systems. A plate frame heat exchanger isolates the units from any contaminating effects of the water source, and allows periodic cleaning of the heat exchanger during off peak hours.

Operation and benefits are similar to those for ground-source systems. Due to the extended loop temperatures, AHRI/ISO 13256-1 Ground Loop Heat Pumps are required for this application. Closed loop plate heat exchanger systems are applicable in commercial, marine, or industrial structures where the many benefits of a water source heat pump system are desired, regardless of whether the load is heating or cooling dominated.

## Application Notes cont.

### Cooler/Boiler - Closed Loop



• **Closed Loop /Cooler-Boiler Systems** utilize a closed heat recovering loop with multiple water source heat pumps in the more conventional manner. Typically a boiler is employed to maintain closed loop temperatures above 60°F and a cooling tower to maintain loop temperatures below 90°F. These systems are applicable in medium to large buildings regardless of whether the load is heating or cooling dominated. Due to the moderate loop temperatures, AHRI/ISO 13256-1 Water Loop Heat Pumps are required for this application.

## Typical Application Piping

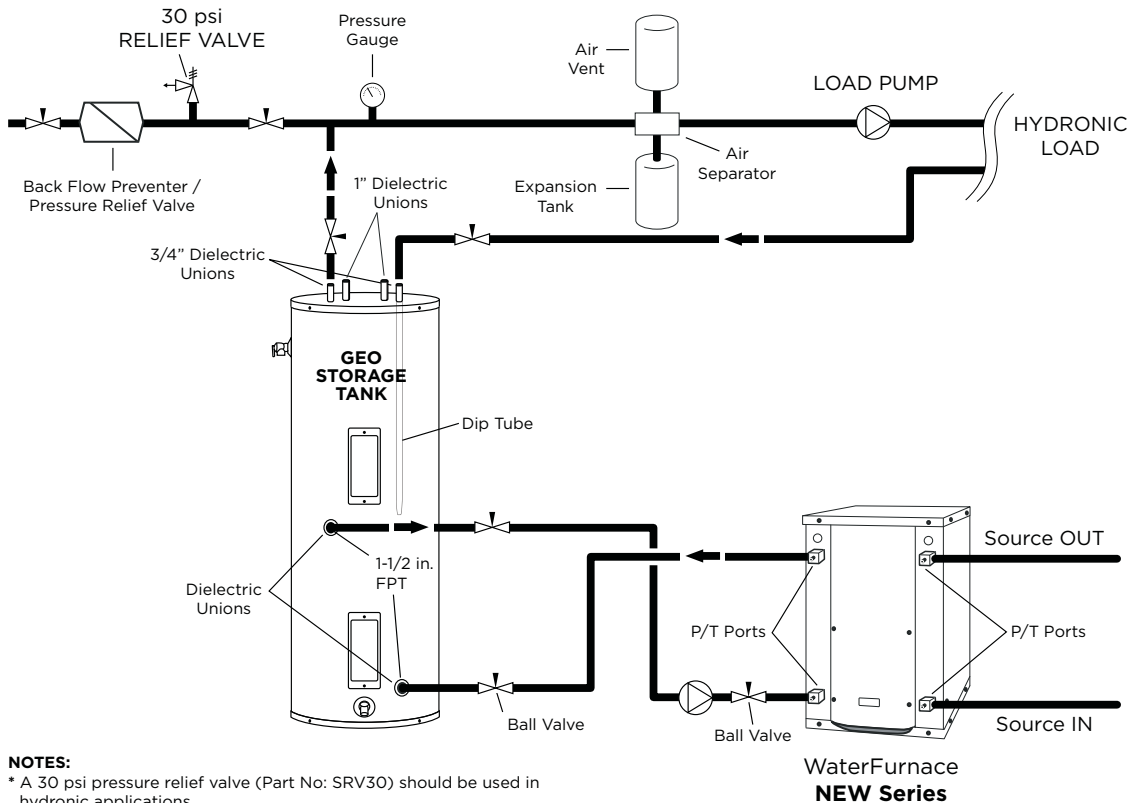



## Application Notes

Heating with hot water is versatile because there are many ways of distributing the heat through the building. The options range from heavy cast iron radiators seen in older buildings to modern, baseboard-style convection radiation, and from invisible radiant floor heating to forced air systems using fan coil units.

The various distribution systems have all been used successfully with a geothermal heat pump system. When designing or retrofitting an existing hydronic heating system, however, the water temperature produced by the heat pump is a major consideration and should be compared to the system requirements.

The efficiency decreases as the temperature difference ( $\Delta T$ ) between the heat load (generally the earth loop) and the supply water (to the distribution system) increases. Figure 1 illustrates the effect of source and load temperatures on the system. The heating capacity of the heat pump also decreases as the temperature difference increases.

When using the various types of hydronic heat distribution systems, the temperature limits of the geothermal system must be considered. In new construction, the distribution system can easily be designed with the temperature limits in mind. In retrofits, care must be taken to address the operating temperature limits of the existing distribution system.

**Figure 1:** As the  $\Delta T$  increases, the Coefficient of Performance (COP) decreases. When the system produces 130°F water from a 30°F earth loop, the  $\Delta T$  is 100°F, and the COP is approximately 2.5. If the system is producing water at 90°F, the  $\Delta T$  is 60°F and the COP rises to about 3.8, an increase of over 50%.

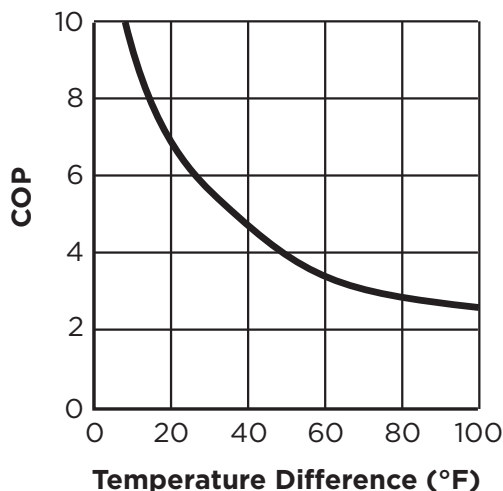

## Baseboard Radiation

In existing systems, baseboard radiation is typically designed to operate with 160° to 240°F water or steam. Baseboard units are typically copper pipe with aluminum fins along the length of the pipe, as shown in Figure 2. A decorative cover is normally fitted over the fin tube.

The operation of a baseboard radiation system depends on setting up a convection current in the room: air is warmed by the fin tube, rises and is displaced by cool air.

The heating capacity of a baseboard system is a factor of the area of copper tube and fins exposed to the air and the temperature difference between the air and the fin tube. The velocity and volume of water flowing through the baseboard affects the temperature of the copper and fins. Baseboard units are normally rated in heat output/length of baseboard at a standard water temperature and flow. Manufacturers can provide charts which will give the capacities at temperatures and flows below the standard. Figure 3 shows approximate heating capacities for fin tube radiation using water from 110 to 150°F water.

Baseboards are available using two or three fin tubes tiered above one another in the same cabinet. With the additional surface area, the air can be heated enough to set up a convection current with water temperatures as low as 110° to 150°F (see Figure 3).

It is important to ensure that the heat output of the system is adequate to meet the heat loss of the room or building at the temperatures the geothermal system is capable of producing.

Baseboard radiation is limited to space heating. Cooling is typically provided by a separate, forced air distribution system.

**Figure 2:** Baseboard radiators are typically constructed of copper tube with closely spaced aluminum fins attached to provide more surface area to dissipate heat. Some of the factors affecting the amount of heat given off by fin tube radiators are the water temperature, water velocity, air temperature, and fin spacing and size.

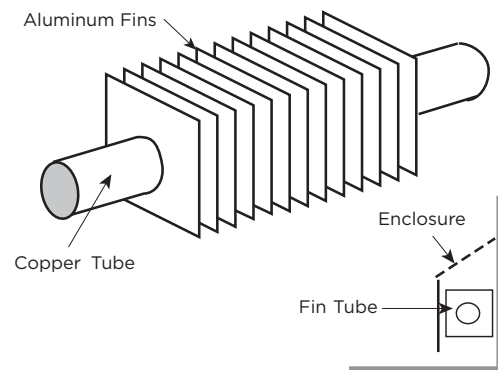

## Application Notes cont.

The heating capacity (Btu/h per linear foot) of baseboard radiators drop as the water temperature is reduced. The heating capacity of most baseboard radiators is rated using 200°F water, 65°F air temperature. Listed in Figure 3 is the range of heating capacities of baseboard radiators at the standard temperatures and the range of capacities when the temperatures are reduced to the operating range of a heat pump system. Some of the factors that affect the capacity of a radiator are:

- Size of the fins - range from 2.75 in. x 3 in. to 4 in. x 4 in.
- Fin spacing - 24 to 48/foot
- Diameter of copper tube - range from .75 in. to 2 in.
- Fin material - aluminum or steel
- Configuration and height of the enclosure
- Height unit is mounted from the floor
- Water flow through the radiator

Generally, the smaller fins with fewer fins/foot will have lower heating capacity. Larger copper tube diameter and aluminum fins will have a higher capacity. Higher water flow will increase capacity. Adding a second fin tube to the same enclosure will increase the capacity by 50 to 60%. Adding two fin tubes will increase the capacity by 75 to 80%.

**Figure 3:** Heating output per linear foot (Btu/h)

Average Water Temp.	Entering Air Temperatures		
	55°F	65°F	70°F
110°F	190-380	<b>160-320</b>	150-300
120°F	240-480	<b>205-410</b>	195-390
130°F	295-590	<b>265-532</b>	245-490
140°F	355-710	<b>335-650</b>	300-600
150°F	420-830	<b>415-780</b>	360-720

### Cast Iron Radiation

Retrofit applications for hydronic/geothermal heat pump systems are often required to work with existing cast iron radiators or their replacements (see Figure 4). Typically, cast iron radiator systems operate with water temperatures of 125° to 160°F.

The OptiHeat was specifically designed to meet these higher temperatures. Cast iron radiators can work with geothermal systems, provided the heat output of the radiators will meet the maximum heat loss of the building at the lower temperatures.

If the insulation of the building has been upgraded since the original installation, it is possible that the lower temperatures will be able to meet the reduced heat loss of the building.

**Figure 4:** Baseboard System

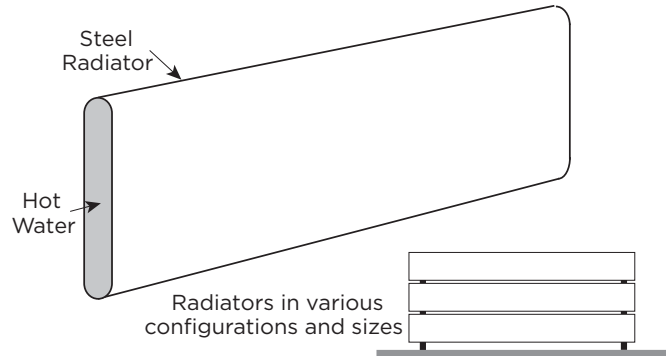

### Radiant Floor Heating

Radiant floor heating has been the system of choice in many parts of Europe for some time. Manufacturers have developed tubing designed for installation in concrete floors and raised wood floors.

Floor heating systems have several benefits in residential, commercial and industrial heating applications. In a building with a radiant floor heating system, the entire floor acts as a heat source for the room. People feel comfortable with lower air temperatures if their feet are warm. Typically the space will feel comfortable with air temperatures as low as 65°F. Since the heat loss of a building is directly related to the temperature difference ( $\Delta T$ ) between the inside and outside, a lower  $\Delta T$  means the heat loss is lower.

Air temperatures in a room with a forced air heating system tend to be warmer nearer to the ceiling than the floor (see Figure 5). The hot air rises and creates a greater pressure imbalance between the inside and outside. The infiltration increases, resulting in a higher heat loss. Air temperatures in a room with radiant floor heating tend to be warmer at the floor than the ceiling, helping to cut down on infiltration in the building. The energy savings in a building with radiant floor heating can range from 10 to 20%.

**Figure 5:** Temperature Comparison

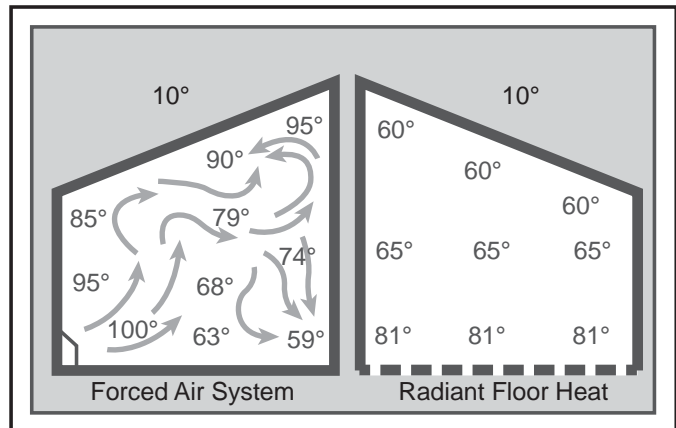

## Application Notes cont.

A floor heat system can be designed to heat a building with water temperatures as low as 90°F.

Figure 1 shows how a geothermal system operates more efficiently with a lower  $\Delta T$  between the source and the load. With only a 60°F temperature difference, a hydronic geothermal heat pump will operate at COPs, about 20% higher than a forced air geothermal system in the same installation.

Some of the factors affecting the heating capacity of a floor heating system are as follows:

- The type of finish flooring
- The spacing of the pipe
- The water flow through the pipe
- The temperature of the supply water
- The floor material (wood, concrete or poured Gypcrete™)
- Insulation value under the floor
- The piping layout

The spacing of the pipe in residential applications can vary from 4 in. to 12 in. If the spacing is too large, the temperature of the floor can vary noticeably. In industrial applications, variation in the floor temperature is not as important, and the spacing is related directly to the heat output required.

Radiant floor heating systems work well with geothermal heat pump systems. For efficient operation, the system must be designed with the lowest possible water temperatures.

There are some drawbacks with a radiant floor heating system. Air conditioning is only possible by adding a second system using forced air. This can add substantial cost to an installation where air conditioning is also needed. A separate air handling system is needed to clean the air or to introduce fresh air.

Industrial buildings, especially those with high ceilings and large overhead doors, have an advantage with a radiant floor heating system. Heat is stored in the concrete floor, and when a door is opened, the stored heat is immediately released to the space. The larger the  $\Delta T$  between the air in the space and the floor, the quicker the floor releases its heat to the space.

Maintenance garages benefit from radiant floor heating systems. Cold vehicles brought into the garage are warmed from underneath. The snow melts off the vehicle and dries much more quickly than when heated from above.

Some pipe manufacturers include an oxygen diffusion barrier in the pipe to prevent oxygen diffusion through the pipe.

Good system design and careful installation, however, will eliminate virtually all of the problems encountered with air in the system. Like earth loop design, it is important to design the system to facilitate flushing the air initially and ensuring that the flows can be balanced properly.

## Fan Coil Units and Air Handlers

Fan coil units, air handlers, force flow units, etc. are all basically a hot water radiator or coil (usually copper piping with aluminum fins) with a fan or blower to move the air over the coil (see Figure 6). The term “fan coil units” typically applies to smaller units that are installed in the zone or area in which heating (or cooling) is needed. They are available in many different configurations, sizes and capacities. Fan coil units are designed to be connected to a ductwork system and can be used to replace a forced air furnace. Other units are designed for use without ductwork and are mounted in a suspended ceiling space with only a grill showing in place of a ceiling tile. Some can be mounted on a wall under a window, projecting 8 in. to 10 in. into the room or even flush to the wall surface, mounted between wall studs. Some are available with or without finished, decorative cabinets. For industrial applications, inexpensive “unit heaters” are available, with only a coil and an axial fan. Fan coil units and unit heaters are normally available with air handling capacities of 200 to 2,000 cfm.

The term “air handler” normally applies to larger units, mounted in mechanical rooms, mechanical crawl spaces or rooftops. They typically have an air handling capacity of over 2,000 cfm and are available for capacities of up to 50,000 cfm. Air handlers are typically built for a specific installation and are available with many different types of heating and cooling coils. They can include additional coils for heating make-up air, dehumidification and exhaust air heat recovery.

Fan coils and air handlers typically have one or two coils and a blower. Air is heated by hot water circulated through the hot water coil. Chilled water is circulated through the coil if air conditioning is needed. Blowers can be provided to fit various applications, with or without duct-work. Unit heaters typically use axial fans in applications where ductwork is not needed.

Fan coil units and air handlers are used in many different applications. They have been used to heat buildings using water temperatures as low as 90° to 100°F. New systems can be designed to operate very efficiently with a geothermal system.

## Application Notes cont.

**Figure 6:** Fan Coils

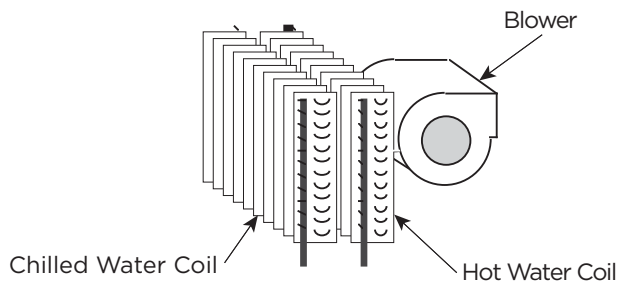

### Cooling with a Hydronic System

Cooling a building with an existing radiant hydronic heating system can be a challenge. If baseboard, cast iron radiators or a radiant floor heating system is cooled lower than the dew point, condensation will form on the floor or drip off the radiators.

There is generally minimal or no ductwork for ventilation in existing buildings with radiant hydronic heat. Typically, cooling is provided with separate units where it is needed. This is often done using through-the-wall or window air conditioners, ductless split air conditioning units, or rooftop units.

A water-to-water heat pump system can provide water to ducted or unducted fan coil units. The system can provide chilled water to cool the building, as well as hot water for the heating system when needed.

A limited amount of cooling can be done by circulating chilled water through the piping in the floor. This can be effective in buildings with high solar loads or lighting loads, where much of the heat gain is radiant heat being absorbed by the floor. Cooling fresh air used for ventilation as it is brought into the building, using a chilled water coil, can sometimes provide the additional cooling needed. Care must be taken to avoid cooling the floor below the dew point because condensation may form on the floor.

Buildings with fan coil units and air handlers can generally be easily retrofitted for cooling. Often it is simply a matter of adding a cooling coil to the existing air handlers and fan coil units. Water-to-water heat pumps can provide hot water for the heating coils as well as chilled water for the air conditioning.

### Controls

The control of a mechanical system determines how it functions. For the building to work efficiently and comfortably, the building owner or manager must understand what the system is doing and how to control it.

As Figure 1 shows, the efficiency of a heat pump is a factor of the difference in temperature between the source and the load. The heat loss or heat gain of a building varies with the weather and the use of the building. As the outdoor temperature decreases, the heat loss of the building increases. When the ventilation system is started up, the heating or cooling loads increase. As the occupancy increases, lighting or the solar gain increases, and the cooling load increases. At times the building may require virtually no heating or cooling.

With hydronic heating and cooling distribution equipment, whether it is baseboard radiation, fan coil units or radiant floor heating, the output of the equipment is directly related to the temperature and velocity of the water flowing through it. Baseboard radiation puts out approximately 50% less heat with 110°F water than with 130°F water. The same is true with fan coil units and radiant floor heating.

If a system is designed to meet the maximum heat loss of a building with 130°F water, it follows that if the heat loss is 50% lower when the outdoor temperature is higher and the building has high internal gains because of lighting and occupancy, the lower heat loss can be met with 110°F water. This greatly increases the COP of the heat pumps.

The same control strategy is equally effective in cooling. During peak loads, water chilled to 40°F may be needed; at other times 55°F water will provide adequate cooling. Significant increases in the EER can be achieved. Latent loads must always be considered when using warmer water.

# Dimensional Data

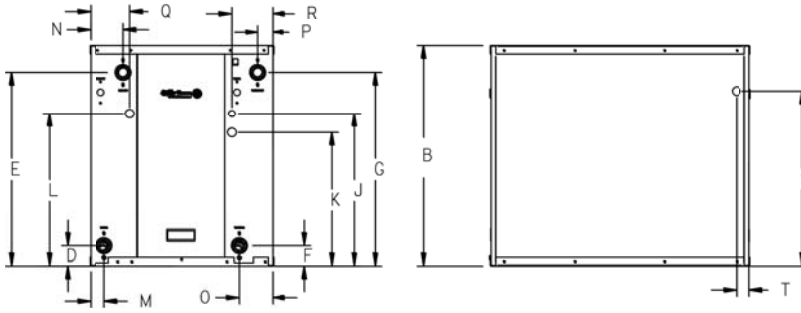
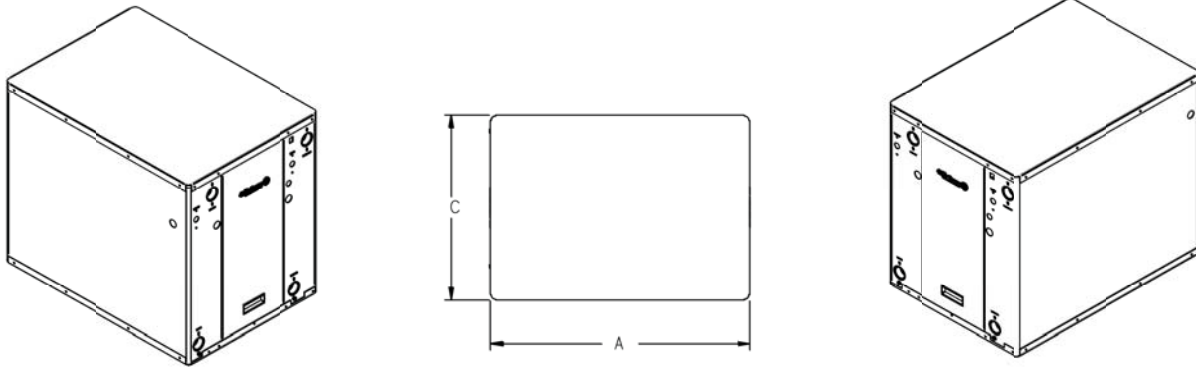

Model	Overall Cabinet			Water Connections						Electrical Knockouts			
	A	B	C	D	E	F	G			J	K	L	
	Depth	Height	Width	Load Liquid In	Load Liquid Out	Source Liquid In	Source Liquid Out	Load Water FPT	Source Water FPT	1/2" cond	3/4" cond	3/4" cond	
040	in.	31.0	26.2	22.0	2.1	19.6	2.1	19.6	1"	1"	17.1	14.8	17.1
	mm	787.4	665.5	558.8	53.3	497.8	53.3	497.8	25.4	25.4	434.3	375.9	434.3
050	in.	31.0	26.2	22.0	2.2	20.6	2.2	20.6	1-1/4"	1-1/4"	17.1	14.8	17.1
	mm	787.4	665.5	558.8	55.9	523.2	55.9	523.2	31.8	31.8	434.3	375.9	434.3
066	in.	31.0	26.2	22.0	2.4	23.0	2.4	23.0	1-1/4"	1-1/4"	17.1	14.8	17.1
	mm	787.4	665.5	558.8	61.0	584.2	61.0	584.2	31.8	31.8	434.3	375.9	434.3

Water Connections				Electrical Knockout	
M	N	O	P	S	T
Load Liquid In	Load Liquid Out	Source Liquid In	Source Liquid Out	Power Supply	Low Voltage
1.6	2.8	2.8	1.6	2.0	1.8
40.6	69.9	69.9	40.6	50.8	45.7
1.8	3.6	3.6	1.8	2.1	1.8
45.7	91.4	91.4	45.7	53.3	45.7
1.8	4.0	4.0	1.8	4.2	1.4
45.7	101.6	101.6	45.7	106.7	35.6

8/28/2014

## Physical Data

Model	040	050	066
Compressor (1 each)	Scroll		
Factory Charge R410A, oz [kg]	94 [2.66]	108 [3.06]	142 [4.02]
Coax & Piping Water Volume - gal [l]	1.0 [3.94]	1.4 [5.25]	1.6 [6.13]
Weight - Operating, lb [kg]	305 [138.3]	340 [154.2]	360 [163.3]
Weight - Packaged, lb [kg]	320 [145.1]	355 [161.0]	375 [170.0]

7/8/14

## Electrical Data

Model	Rated Voltage	Voltage Min/Max	Compressor				Load Pump	Source Pump	Total Unit FLA	Min Ckt Amp	Maximum Fuse/HACR
			MCC	RLA	LRA	LRA*					
040	208-230/60/1	198/254	27.7	17.8	135.0	47.0	1.8	5.4	25.0	29.5	45
050	208-230/60/1	198/254	37.8	24.2	178.0	-	1.8	5.4	31.4	37.5	60
066	208-230/60/1	198/254	40.3	25.8	178.0	-	1.8	5.4	33.0	39.5	60

Notes: All fuses type "D" time delay (or HACR circuit breaker in USA).

7/08/14

Source pump amps shown are for up to a 1/2 HP pump

Load pump amps shown are for small circulators.

\*LRA with IntelliStart installed

## Antifreeze Correction

Catalog performance can be corrected for antifreeze use. Please use the following table and note the example given.

Antifreeze Type	Antifreeze % by wt	Heating		Cooling		Pressure Drop
		Load	Source	Load	Source	
EWT - °F [°C]		<b>80 [26.7]</b>	<b>30 [-1.1]</b>	<b>50 [10.0]</b>	<b>90 [32.2]</b>	<b>30 [-1.1]</b>
Water	0	1.000	1.000	1.000	1.000	1.000
Ethylene Glycol	10	0.990	0.973	0.976	0.991	1.075
	20	0.978	0.943	0.947	0.979	1.163
	30	0.964	0.917	0.921	0.965	1.225
	40	0.953	0.890	0.897	0.955	1.324
	50	0.942	0.865	0.872	0.943	1.419
Propylene Glycol	10	0.981	0.958	0.959	0.981	1.130
	20	0.967	0.913	0.921	0.969	1.270
	30	0.946	0.854	0.869	0.950	1.433
	40	0.932	0.813	0.834	0.937	1.614
	50	0.915	0.770	0.796	0.922	1.816
Ethanol	10	0.986	0.927	0.945	0.991	1.242
	20	0.967	0.887	0.906	0.972	1.343
	30	0.944	0.856	0.869	0.947	1.383
	40	0.926	0.815	0.830	0.930	1.523
	50	0.907	0.779	0.795	0.911	1.639
Methanol	10	0.985	0.957	0.962	0.986	1.127
	20	0.969	0.924	0.929	0.970	1.197
	30	0.950	0.895	0.897	0.951	1.235
	40	0.935	0.863	0.866	0.936	1.323
	50	0.919	0.833	0.836	0.920	1.399



**WARNING:** Gray area represents antifreeze concentrations greater than 35% by weight and should be avoided due to the extreme performance penalty they represent.

### Antifreeze Correction Example

Antifreeze solution is propylene glycol 20% by weight for the source and methanol 10% for the load. Determine the corrected heating at 30°F source and 80°F load as well as pressure drop at 30°F for an O50. Also, determine the corrected cooling at 90°F source and 50°F load.

The corrected heating capacity at 30°F/80°F would be:

$$45,600 \text{ BTU/H} \times 0.913 \times 0.985 = 41,008 \text{ BTU/H}$$

The corrected cooling capacity at 90°F/50°F would be:

$$41,700 \times 0.969 \times 0.962 = 38,871 \text{ BTU/H}$$

The corrected pressure drop at 30°F and 15 GPM would be:

$$5.6 \text{ psi} \times 1.270 = 7.11 \text{ psi}$$



# Water Pressure Drop

## Model 040

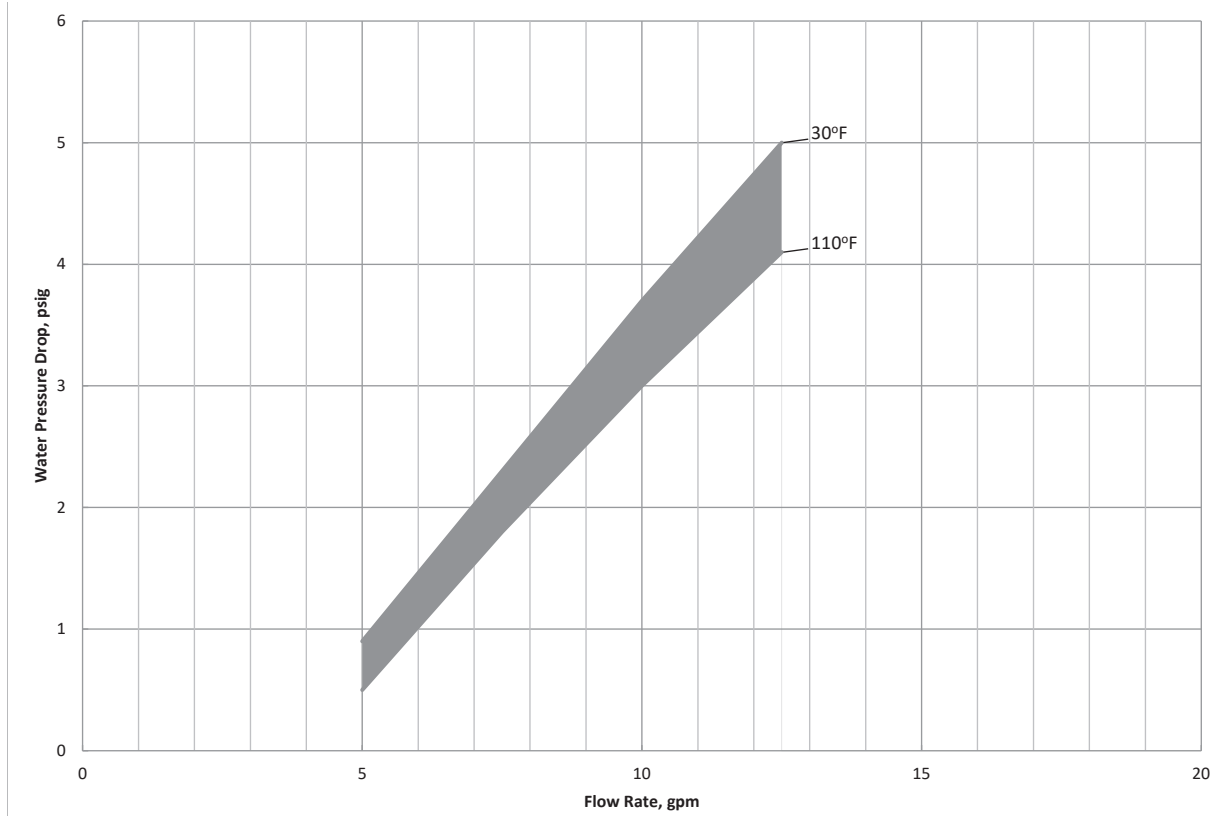

## Model 050

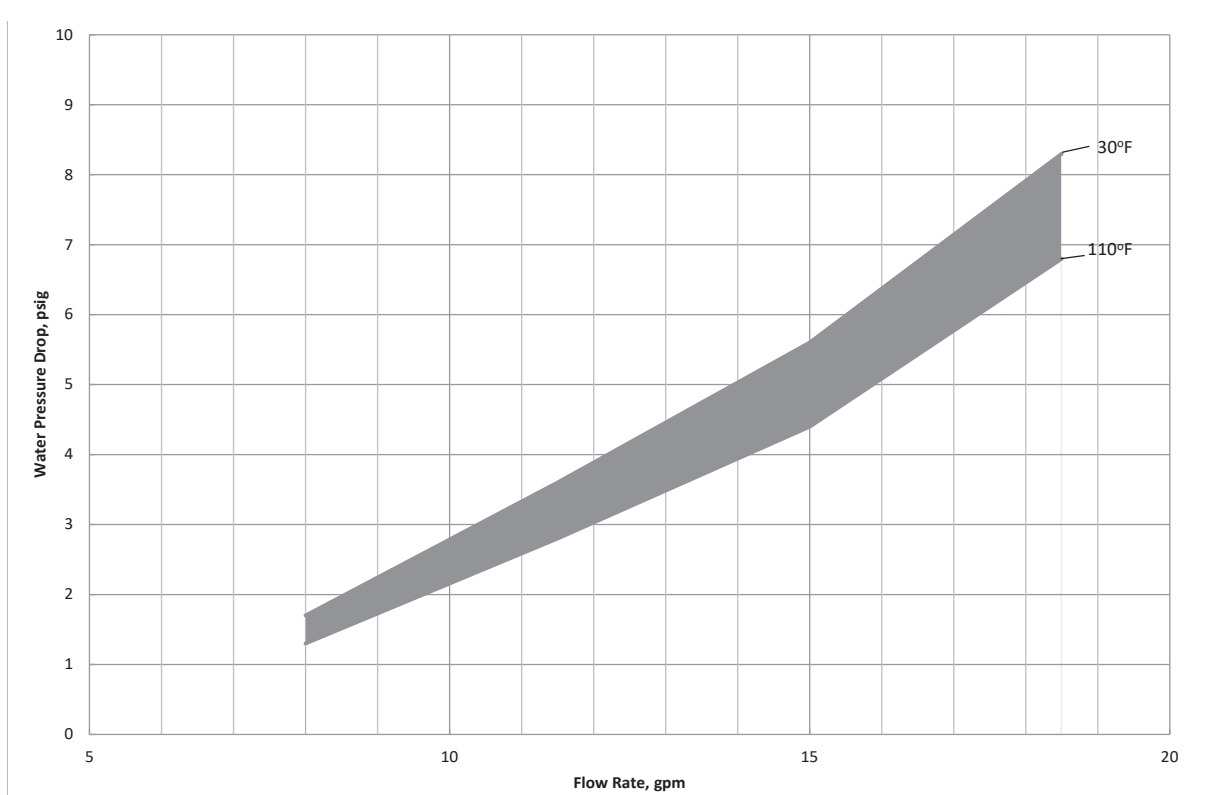

## Water Pressure Drop cont.

### Model 066

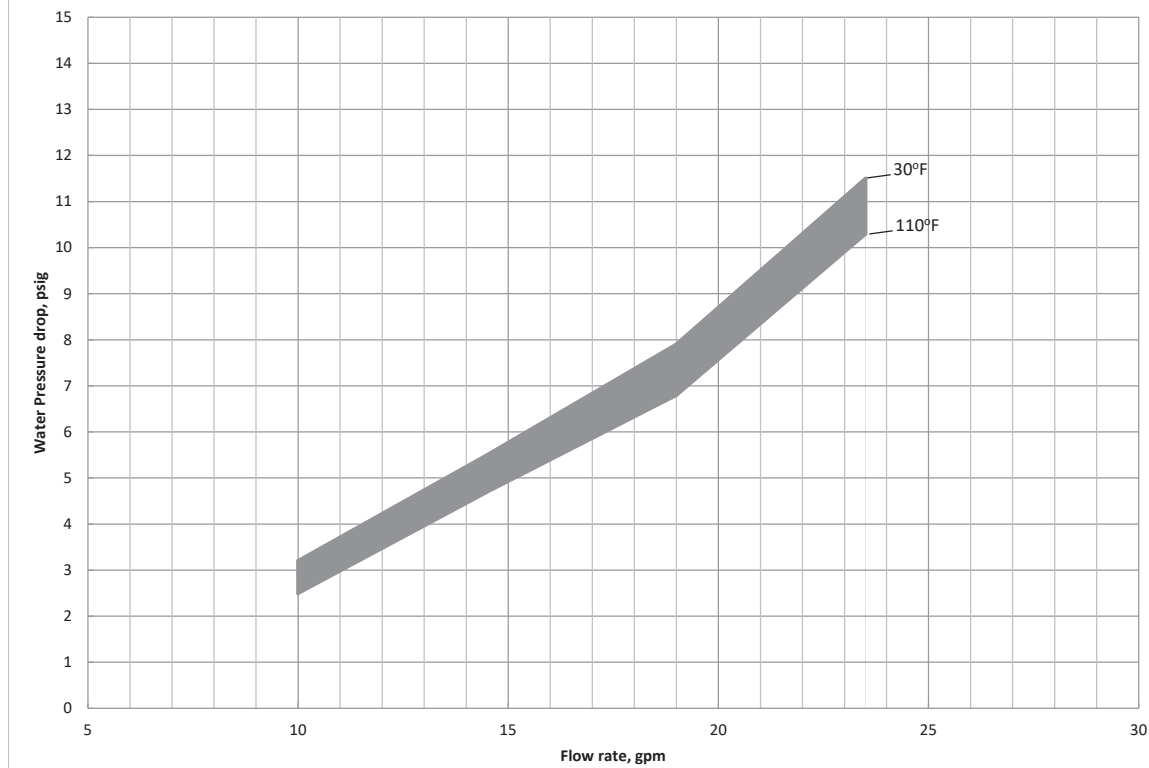

## Pressure Drop

Model	GPM	Pressure Drop (psi)						
		30°F	50°F	70°F	90°F	110°F	130°F	150°F
040	5.0	0.9	0.6	0.6	0.5	0.5	0.4	0.3
	7.5	2.3	2.1	2.0	1.9	1.8	1.6	1.5
	10.0	3.7	3.5	3.3	3.2	3.0	2.8	2.7
	12.5	5.0	4.7	4.4	4.2	4.1	3.9	3.7
050	8.0	1.7	1.4	1.4	1.3	1.3	1.2	1.1
	11.5	3.6	3.4	3.2	3.0	2.8	2.6	2.5
	15.0	5.6	5.4	5.0	4.6	4.4	4.3	4.1
	18.5	8.3	8.1	7.6	7.2	6.8	6.6	6.4
066	10.0	3.2	3.0	2.8	2.7	2.5	2.4	2.3
	14.5	5.5	5.3	5.1	4.9	4.7	4.6	4.5
	19.0	7.9	7.6	7.3	7.1	6.8	6.6	6.5
	23.5	11.5	11.3	11.0	10.8	10.3	10.1	9.9

7/8/14

## Heating Operating Envelope

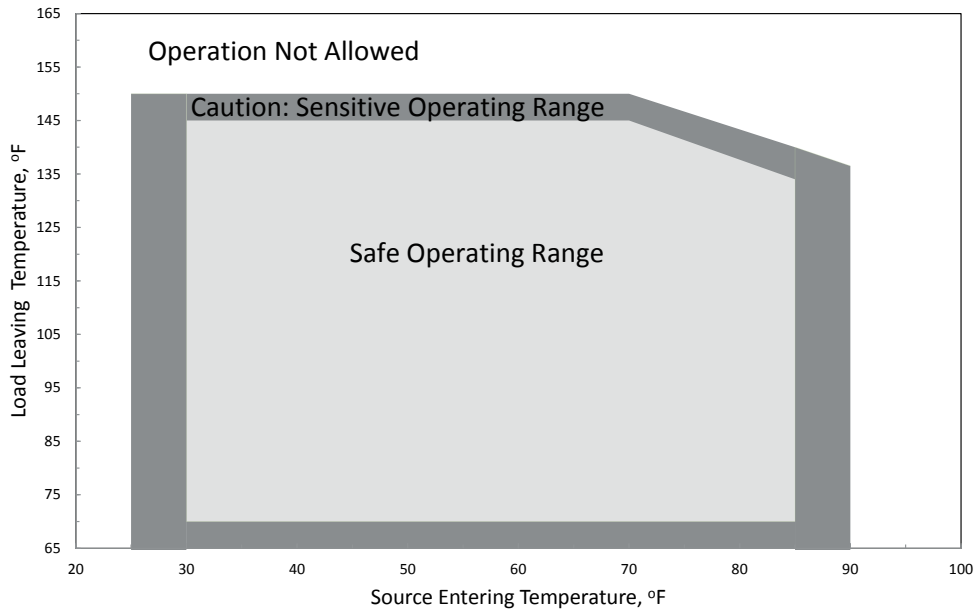

## Cooling Operating Envelope

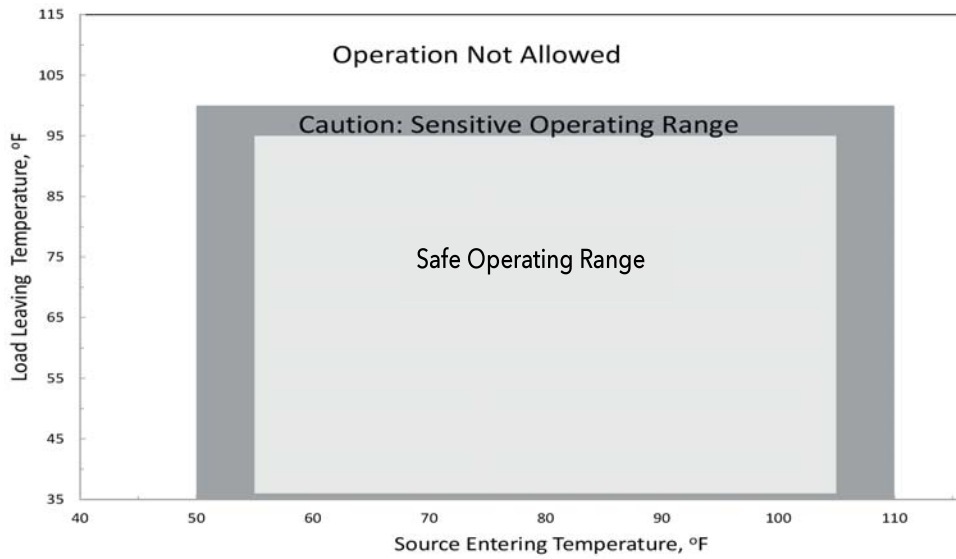

## Reference Calculations

<p><b>Heating Calculations:</b></p> $LWT = EWT - \frac{HE}{GPM \times C^*}$ $HE = C^* \times GPM \times (EWT - LWT)$	<p><b>Cooling Calculations:</b></p> $LWT = EWT + \frac{HR}{GPM \times C^*}$ $HR = C^* \times GPM \times (LWT - EWT)$
--	--

**NOTE:** \* C = 500 for pure water, 485 for brine.

## Legend and Notes

### Abbreviations and Definitions

ELT = entering load fluid temperature to heat pump	kW = kilowatts
SWPD = source coax water pressure drop	EST = entering source fluid temperature to heat pump
LLT = leaving load fluid temperature from heat pump	HE = heat extracted in MBTUH
PSI = pressure drop in pounds per square inch	LST = leaving source fluid temperature from heat pump
LGPM = load flow in gallons per minute	HC = total heating capacity in MBTUH
FT HD = pressure drop in feet of head	COP = coefficient of performance, heating [HC/kW x 3.413]
LWPD = load coax water pressure drop	EER = energy efficiency ratio, cooling
LWT = leaving water temperature	TC = total cooling capacity in MBTUH
EWT = entering water temperature	HR = heat rejected in MBTUH
Brine = water with a freeze inhibiting solution	

### Notes to Performance Data Tables

The following notes apply to all performance data tables:

- Three flow rates are shown for each unit. The lowest flow rate shown is used for geothermal open loop/well water systems with a minimum of 50°F EST. The middle flow rate shown is the minimum geothermal closed loop flow rate. The highest flow rate shown is optimum for geothermal closed loop systems and the suggested flow rate for boiler/tower applications.
- Entering water temperatures below 40°F assumes 15% antifreeze solution.
- Interpolation between ELT, EST, and GPM data is permissible.
- Operation in the gray areas is not recommended.

# Performance Data

## 040-Heating

Source		Load Flow - 5 GPM							Load Flow - 8 GPM							Load Flow - 10 GPM						
EST °F	Flow GPM	ELT °F	LLT °F	HC MBTUH	Power kW	HE MBTUH	COP	LST °F	LLT °F	HC MBTUH	Power kW	HE MBTUH	COP	LST °F	LLT °F	HC MBTUH	Power kW	HE MBTUH	COP	LST °F		
30	5	60	72.7	31.7	1.8	25.4	5.0	19.5	68.0	32.0	1.8	25.8	5.2	19.3	66.4	32.2	1.8	26.2	5.4	19.2		
		80	93.0	32.5	2.3	24.6	4.1	19.9	88.2	32.8	2.3	25.1	4.2	19.7	86.6	33.0	2.2	25.4	4.3	19.5		
		100	113.3	33.4	3.0	23.3	3.3	20.4	108.4	33.7	2.9	23.9	3.4	20.2	106.8	33.9	2.8	24.3	3.5	20.0		
		130	144.0	35.0	3.9	21.8	2.6	21.0	138.8	35.3	3.8	22.5	2.7	20.7	137.1	35.5	3.7	22.9	2.8	20.5		
		140	Operation not recommended							148.9	35.5	4.2	21.2	2.5	21.3	147.1	35.7	4.1	21.7	2.5	21.1	
	8	60	73.0	32.4	1.9	26.1	5.1	23.3	68.2	32.7	1.8	26.5	5.3	23.2	66.6	32.9	1.8	26.9	5.4	23.1		
		80	93.3	33.2	2.5	24.7	3.9	23.6	88.4	33.5	2.4	25.3	4.1	23.5	86.7	33.7	2.4	25.6	4.2	23.4		
		100	113.6	33.9	3.1	23.4	3.2	24.0	108.6	34.3	3.0	24.0	3.3	23.8	106.9	34.5	3.0	24.4	3.4	23.7		
		130	144.0	35.1	4.0	21.3	2.5	24.5	138.9	35.4	3.9	22.0	2.6	24.3	137.1	35.6	3.8	22.5	2.7	24.2		
		140	Operation not recommended							149.0	35.8	4.2	21.4	2.5	24.5	147.2	36.0	4.1	21.9	2.6	24.4	
	10	60	73.2	32.9	1.9	26.5	5.2	24.5	68.3	33.2	1.8	27.0	5.4	24.4	66.7	33.4	1.8	27.3	5.5	24.4		
		80	93.5	33.8	2.4	25.7	4.2	24.7	88.5	34.1	2.3	26.3	4.4	24.6	86.9	34.3	2.3	26.6	4.5	24.5		
100		113.8	34.5	3.0	24.3	3.4	25.0	108.7	34.8	2.9	24.9	3.5	24.9	107.0	35.0	2.8	25.3	3.6	24.8			
130		144.2	35.5	3.9	22.1	2.7	25.4	138.9	35.8	3.8	22.8	2.8	25.3	137.2	36.0	3.7	23.3	2.8	25.2			
140		Operation not recommended							149.0	36.0	4.2	21.5	2.5	25.6	147.2	36.2	4.2	22.0	2.6	25.5		
50	5	60	74.8	37.0	1.8	30.9	6.1	37.3	69.3	37.3	1.7	31.4	6.3	37.1	67.5	37.5	1.7	31.7	6.5	36.9		
		80	95.2	38.1	2.3	30.4	4.9	37.5	89.6	38.4	2.2	30.9	5.1	37.2	87.7	38.7	2.2	31.3	5.3	37.1		
		100	115.6	39.0	3.0	29.0	3.9	38.1	109.8	39.4	2.9	29.6	4.0	37.8	107.9	39.6	2.8	30.0	4.1	37.6		
		130	146.4	41.0	3.8	28.1	3.2	38.4	140.3	41.3	3.7	28.9	3.3	38.1	138.3	41.6	3.6	29.3	3.4	37.9		
		140	Operation not recommended							Operation not recommended							148.4	42.0	4.2	27.8	3.0	38.5
	8	60	75.1	37.8	1.8	31.7	6.2	41.8	69.5	38.2	1.7	32.2	6.4	41.7	67.7	38.4	1.7	32.6	6.6	41.6		
		80	95.5	38.8	2.4	30.4	4.6	42.2	89.8	39.2	2.4	31.0	4.8	42.0	87.9	39.4	2.3	31.4	5.0	41.9		
		100	115.9	39.8	3.1	29.2	3.8	42.5	110.0	40.1	3.0	29.9	3.9	42.3	108.1	40.4	3.0	30.3	4.0	42.2		
		130	146.5	41.2	4.1	27.3	3.0	43.0	140.4	41.6	4.0	28.1	3.1	42.8	138.4	41.9	3.9	28.6	3.2	42.6		
		140	Operation not recommended							Operation not recommended							148.5	42.4	4.2	28.1	3.0	42.8
	10	60	75.4	38.4	1.8	32.2	6.2	43.4	69.7	38.7	1.8	32.8	6.5	43.2	67.8	39.0	1.7	33.1	6.6	43.2		
		80	95.8	39.5	2.3	31.7	5.1	43.5	90.0	39.9	2.2	32.3	5.3	43.3	88.0	40.1	2.2	32.7	5.4	43.3		
100		116.1	40.3	3.0	30.2	4.0	43.8	110.2	40.7	2.9	30.9	4.1	43.6	108.2	40.9	2.8	31.3	4.2	43.5			
130		146.6	41.5	3.8	28.6	3.2	44.1	140.5	41.9	3.7	29.3	3.3	44.0	138.4	42.1	3.6	29.8	3.4	43.9			
140		Operation not recommended							Operation not recommended							148.5	42.6	4.2	28.3	3.0	44.2	
70	5	60	77.1	42.8	1.8	36.8	7.1	54.8	70.8	43.2	1.7	37.3	7.4	54.6	68.7	43.4	1.7	37.7	7.6	54.4		
		80	99.0	47.4	3.0	37.2	4.6	54.7	91.3	45.2	2.6	36.4	5.1	55.0	88.8	43.8	2.3	35.9	5.6	55.2		
		100	120.8	52.0	4.2	37.6	3.6	54.5	111.9	47.6	3.4	36.0	4.1	55.2	108.9	44.7	2.9	34.9	4.5	55.6		
		130	153.5	58.9	6.1	38.2	2.8	54.3	142.8	51.0	4.8	34.8	3.1	55.7	139.2	45.8	3.9	32.5	3.4	56.6		
		140	Operation not recommended							Operation not recommended							149.2	45.9	4.2	31.6	3.2	57.0
	8	60	78.0	44.9	1.8	38.9	7.5	60.0	71.2	44.6	1.7	38.8	7.6	60.0	68.9	44.4	1.7	38.7	7.8	60.0		
		80	99.9	49.7	3.0	39.5	4.9	59.8	91.7	46.8	2.6	38.0	5.3	60.2	89.0	44.9	2.3	37.0	5.7	60.5		
		100	121.8	54.6	4.2	40.1	3.8	59.7	112.3	49.0	3.5	37.2	4.1	60.4	109.1	45.4	3.0	35.3	4.5	60.9		
		130	154.7	61.8	6.1	41.0	3.0	59.4	143.1	52.4	4.8	36.0	3.2	60.7	139.2	46.1	3.9	32.7	3.4	61.6		
		140	Operation not recommended							Operation not recommended							149.3	46.3	4.2	31.8	3.2	61.8
	10	60	78.5	46.3	1.8	40.3	7.7	61.7	71.4	45.6	1.7	39.7	7.8	61.8	69.0	45.1	1.7	39.4	7.9	61.9		
		80	100.5	51.3	3.0	41.0	5.0	61.5	91.9	47.8	2.6	38.9	5.4	62.0	89.1	45.5	2.3	37.5	5.7	62.3		
100		122.5	56.3	4.3	41.8	3.9	61.4	112.6	50.2	3.4	38.5	4.3	62.1	109.2	46.2	2.9	36.3	4.7	62.5			
130		155.5	63.8	6.1	42.9	3.0	61.2	143.3	53.3	4.8	36.9	3.3	62.4	139.3	46.3	3.9	33.0	3.5	63.2			
140		Operation not recommended							Operation not recommended							149.3	46.5	4.2	32.0	3.2	63.4	
90	5	60	81.1	52.7	1.7	47.0	9.1	70.6	73.3	53.2	1.7	47.6	9.4	70.4	70.7	53.5	1.6	48.0	9.6	70.2		
		80	101.3	53.3	2.3	45.5	6.8	71.2	93.4	53.8	2.2	46.2	7.0	71.0	90.8	54.1	2.2	46.6	7.2	70.8		
		100	121.7	54.3	2.9	44.6	5.6	71.6	113.7	54.8	2.8	45.3	5.7	71.3	111.0	55.2	2.8	45.7	5.8	71.1		
		130	151.7	54.3	3.8	41.4	4.2	72.9	143.7	54.8	3.7	42.1	4.3	72.6	141.0	55.1	3.7	42.6	4.4	72.4		
		140	Operation not recommended																			
	z8	60	81.6	54.0	1.7	48.2	9.3	77.6	73.6	54.4	1.7	48.8	9.6	77.4	71.0	54.8	1.6	49.2	9.8	77.3 <sup>4</sup>		
		80	105.1	62.8	3.5	50.7	5.2	76.9	94.5	57.9	2.8	48.4	6.1	77.5	90.9	54.7	2.3	46.8	7.0	77.9		
		100	128.6	71.6	5.4	53.2	3.9	76.3	115.3	61.4	3.9	47.9	4.6	77.6	110.9	54.5	3.0	44.4	5.4	78.5		
		130	163.9	84.8	8.2	57.0	3.0	75.3	146.6	66.6	5.6	47.3	3.5	77.8	140.9	54.4	4.0	40.9	4.0	79.5		
		140	Operation not recommended																			
	10	60	81.9	54.8	1.7	48.9	9.4	79.9	73.8	55.3	1.7	49.6	9.7	79.8	71.1	55.6	1.7	50.0	9.9	79.7		
		80	102.1	55.4	2.3	47.5	7.0	80.2	94.0	55.9	2.3	48.1	7.2	80.1	91.2	56.2	2.2	48.6	7.4	80.0		
100		122.5	56.1	2.9	46.3	5.7	80.4	114.2	56.7	2.8	47.0	5.9	80.3	111.4	57.0	2.8	47.5	6.0	80.2			
130		152.0	55.0	3.8	42.0	4.2	81.3	143.9	55.5	3.7	42.7	4.4	81.2	141.2	55.8	3.7	43.2	4.4	81.1			
140		Operation not recommended																				

# Performance Data cont.

## 040-Cooling

Source		Load Flow - 5 GPM							Load Flow - 8 GPM							Load Flow - 10 GPM						
EST °F	Flow GPM	ELT °F	LLT °F	TC MBTUH	Power kW	HR MBTUH	EER	LST °F	LLT °F	TC MBTUH	Power kW	HR MBTUH	EER	LST °F	LLT °F	TC MBTUH	Power kW	HR MBTUH	EER	LST °F		
50	5	50	38.7	28.3	1.62	33.8	17.5	63.5	42.7	29.1	1.62	34.6	18.0	63.9	44.1	29.7	1.62	35.2	18.3	64.1		
		70	57.6	30.9	1.62	36.4	19.0	64.6	62.1	31.6	1.63	37.1	19.4	64.9	63.6	32.1	1.63	37.6	19.7	65.0		
		90	76.6	33.5	1.63	39.1	20.6	65.6	81.5	34.1	1.63	39.6	20.9	65.9	83.1	34.4	1.63	40.0	21.1	66.0		
		110	95.5	36.2	1.64	41.7	22.1	66.7	100.9	36.6	1.64	42.1	22.3	66.9	102.6	36.8	1.64	42.4	22.5	67.0		
	8	50	39.0	27.4	1.56	32.7	17.6	58.2	43.0	28.1	1.56	33.5	18.0	58.4	44.3	28.6	1.56	34.0	18.3	58.5		
		70	58.1	29.8	1.56	35.1	19.1	58.8	62.4	30.4	1.56	35.7	19.5	58.9	63.8	30.8	1.56	36.2	19.7	59.0		
		90	77.2	32.1	1.56	37.4	20.6	59.4	81.8	32.7	1.56	38.0	20.9	59.5	83.4	33.0	1.56	38.3	21.1	59.6		
		110	96.2	34.5	1.56	39.8	22.1	60.0	101.3	34.9	1.56	40.2	22.3	60.1	103.0	35.2	1.56	40.5	22.5	60.1		
	10	50	39.3	26.8	1.52	32.0	17.6	56.4	43.1	27.5	1.52	32.7	18.1	56.5	44.4	28.0	1.52	33.1	18.4	56.6		
		70	58.4	29.0	1.52	34.2	19.1	56.8	62.6	29.6	1.52	34.8	19.5	57.0	64.0	30.0	1.52	35.2	19.8	57.0		
		90	77.5	31.2	1.52	36.4	20.6	57.3	82.1	31.7	1.52	36.9	20.9	57.4	83.6	32.1	1.52	37.2	21.2	57.4		
		110	96.7	33.4	1.52	38.5	22.0	57.7	101.5	33.8	1.51	39.0	22.3	57.8	103.2	34.1	1.51	39.3	22.6	57.9		
70	5	50	39.5	26.3	2.02	33.1	13.0	83.3	43.2	27.1	2.02	34.0	13.4	83.6	44.5	27.7	2.03	34.6	13.7	83.9		
		70	58.1	29.7	2.04	36.7	14.6	84.7	62.4	30.5	2.04	37.5	14.9	85.0	63.8	31.1	2.05	38.1	15.2	85.2		
		90	76.7	33.2	2.06	40.2	16.1	86.1	81.5	33.9	2.06	41.0	16.4	86.4	83.1	34.4	2.07	41.5	16.7	86.6		
		110	95.3	36.7	2.08	43.8	17.6	87.5	100.7	37.3	2.08	44.4	17.9	87.8	102.4	37.8	2.09	44.9	18.1	88.0		
	8	50	39.8	25.6	1.95	32.3	13.1	78.1	43.4	26.4	1.96	33.1	13.5	78.3	44.6	27.0	1.96	33.6	13.8	78.4		
		70	58.5	28.9	1.96	35.6	14.7	78.9	62.6	29.7	1.97	36.4	15.1	79.1	64.0	30.2	1.97	36.9	15.3	79.2		
		90	77.1	32.1	1.98	38.9	16.3	79.7	81.8	32.9	1.98	39.6	16.6	79.9	83.3	33.4	1.98	40.2	16.9	80.0		
		110	95.8	35.4	1.99	42.2	17.8	80.5	101.0	36.1	1.99	42.9	18.1	80.7	102.7	36.6	1.99	43.4	18.4	80.9		
	10	50	39.9	25.2	1.91	31.7	13.2	76.3	43.5	25.9	1.91	32.5	13.6	76.5	44.7	26.5	1.91	33.0	13.8	76.6		
		70	58.7	28.3	1.92	34.8	14.8	77.0	62.7	29.1	1.92	35.6	15.2	77.1	64.1	29.6	1.92	36.1	15.4	77.2		
		90	77.4	31.4	1.92	38.0	16.3	77.6	82.0	32.2	1.92	38.8	16.7	77.8	83.5	32.7	1.92	39.3	17.0	77.9		
		110	96.2	34.5	1.93	41.1	17.9	78.2	101.2	35.3	1.93	41.9	18.3	78.4	102.8	35.8	1.93	42.4	18.6	78.5		
90	5	50	40.3	24.2	2.41	32.5	10.0	103.0	43.7	25.1	2.42	33.4	10.4	103.4	44.8	25.8	2.43	34.0	10.6	103.6		
		70	58.6	28.6	2.45	36.9	11.7	104.8	62.6	29.5	2.46	37.9	12.0	105.1	64.0	30.1	2.47	38.5	12.2	105.4		
		90	76.9	32.9	2.49	41.4	13.2	106.5	81.6	33.8	2.50	42.3	13.5	106.9	83.1	34.4	2.50	42.9	13.7	107.2		
		110	95.1	37.2	2.52	45.8	14.8	108.3	100.5	38.1	2.53	46.7	15.1	108.7	102.3	38.7	2.54	47.4	15.3	109.0		
	8	50	40.5	23.8	2.34	31.8	10.2	98.0	43.8	24.7	2.35	32.7	10.5	98.2	44.9	25.3	2.36	33.3	10.7	98.3		
		70	58.8	28.0	2.37	36.1	11.8	99.0	62.8	28.9	2.37	37.0	12.2	99.3	64.1	29.5	2.38	37.6	12.4	99.4		
		90	77.1	32.1	2.39	40.3	13.4	100.1	81.7	33.1	2.40	41.3	13.8	100.3	83.2	33.8	2.40	42.0	14.1	100.5		
		110	95.5	36.3	2.42	44.6	15.0	101.1	100.7	37.3	2.42	45.6	15.4	101.4	102.4	38.0	2.42	46.3	15.7	101.6		
	10	50	40.6	23.5	2.30	31.3	10.2	96.3	43.9	24.4	2.30	32.2	10.6	96.4	45.0	25.0	2.31	32.8	10.8	96.6		
		70	59.0	27.6	2.31	35.5	11.9	97.1	62.9	28.5	2.32	36.4	12.3	97.3	64.2	29.2	2.32	37.1	12.6	97.4		
		90	77.3	31.7	2.33	39.6	13.6	97.9	81.8	32.7	2.33	40.6	14.0	98.1	83.3	33.4	2.33	41.3	14.3	98.3		
		110	95.7	35.7	2.35	43.7	15.2	98.7	100.8	36.8	2.35	44.8	15.7	99.0	102.5	37.6	2.35	45.6	16.0	99.1		
110	5	50	41.1	22.2	2.81	31.8	7.9	122.7	44.2	23.2	2.83	32.8	8.2	123.1	45.2	23.8	2.83	33.5	8.4	123.4		
		70	59.0	27.4	2.86	37.2	9.6	124.9	62.9	28.4	2.88	38.2	9.9	125.3	64.2	29.1	2.89	38.9	10.1	125.6		
		90	77.0	32.5	2.91	42.5	11.2	127.0	81.6	33.6	2.93	43.6	11.5	127.5	83.1	34.4	2.94	44.4	11.7	127.8		
		110	94.9	37.7	2.96	47.8	12.7	129.1	100.3	38.9	2.98	49.0	13.1	129.6	102.1	39.7	2.99	49.9	13.3	129.9		
	8	50	41.2	22.0	2.74	31.4	8.0	117.8	44.3	23.0	2.75	32.3	8.4	118.1	45.3	23.6	2.75	33.0	8.6	118.2		
		70	59.2	27.1	2.77	36.5	9.8	119.1	63.0	28.2	2.78	37.7	10.1	119.4	64.2	28.9	2.79	38.4	10.4	119.6		
		90	77.1	32.1	2.81	41.7	11.5	120.4	81.7	33.4	2.82	43.0	11.9	120.7	83.2	34.2	2.82	43.8	12.1	120.9		
		110	95.1	37.2	2.84	46.9	13.1	121.7	100.4	38.6	2.85	48.3	13.5	122.1	102.1	39.5	2.85	49.2	13.8	122.3		
	10	50	41.3	21.9	2.69	31.0	8.1	116.2	44.3	22.8	2.70	32.0	8.5	116.4	45.3	23.5	2.70	32.7	8.7	116.5		
		70	59.2	26.9	2.71	36.1	9.9	117.2	63.0	28.0	2.72	37.3	10.3	117.5	64.3	28.7	2.72	38.0	10.6	117.6		
		90	77.2	31.9	2.74	41.2	11.7	118.2	81.7	33.2	2.74	42.5	12.1	118.5	83.2	34.0	2.74	43.4	12.4	118.7		
		110	95.2	36.9	2.76	46.3	13.4	119.3	100.4	38.4	2.76	47.8	13.9	119.6	102.1	39.3	2.76	48.8	14.2	119.8		



# Performance Data cont.

## 050-Heating

Source		Load Flow - 8 GPM							Load Flow - 12 GPM							Load Flow - 15 GPM						
EST	Flow	ELT	LLT	HC	Power	HE	COP	LST	LLT	HC	Power	HE	COP	LST	LLT	HC	Power	HE	COP	LST		
°F	GPM	°F	°F	MBTUH	kW	MBTUH		°F	°F	MBTUH	kW	MBTUH		°F	°F	MBTUH	kW	MBTUH		°F		
30	8	60	70.8	43.2	2.60	34.3	4.87	21.2	67.6	43.5	2.54	34.8	5.02	21.0	65.8	43.8	2.48	35.4	5.19	20.9		
		80	91.0	43.9	3.33	32.6	3.87	21.6	87.7	44.3	3.25	33.2	3.99	21.5	85.9	44.6	3.17	33.8	4.12	21.3		
		100	111.2	44.8	4.01	31.1	3.27	22.0	107.9	45.2	3.92	31.8	3.38	21.8	106.1	45.5	3.82	32.5	3.49	21.6		
		130	141.7	46.9	5.19	29.2	2.65	22.5	138.2	47.2	5.07	29.9	2.73	22.3	136.3	47.6	4.95	30.7	2.82	22.1		
		140	Operation not recommended							148.3	47.6	5.80	27.8	2.41	22.8	146.4	48.0	5.66	28.7	2.48	22.6	
	12	60	71.0	44.0	2.61	35.1	4.94	23.7	67.7	44.3	2.55	35.6	5.09	23.6	66.0	44.7	2.49	36.2	5.26	23.5		
		80	91.2	44.9	3.45	33.1	3.81	24.1	87.9	45.2	3.37	33.7	3.94	24.0	86.1	45.6	3.29	34.4	4.06	23.8		
		100	111.4	45.8	4.29	31.1	3.13	24.4	108.0	46.1	4.19	31.8	3.23	24.3	106.2	46.5	4.08	32.5	3.34	24.2		
		130	141.8	47.1	5.55	28.2	2.49	24.9	138.3	47.5	5.41	29.0	2.57	24.8	136.4	47.8	5.28	29.8	2.65	24.7		
		140	Operation not recommended							148.3	47.9	5.82	28.1	2.41	25.0	146.4	48.3	5.68	28.9	2.49	24.8	
	15	60	71.2	44.8	2.63	35.9	5.00	25.1	67.9	45.2	2.56	36.4	5.16	25.0	66.1	45.5	2.50	37.0	5.33	24.9		
		80	91.4	45.6	3.36	34.1	3.98	25.3	88.0	46.0	3.28	34.8	4.11	25.2	86.2	46.3	3.20	35.4	4.24	25.1		
100		111.6	46.3	4.03	32.5	3.37	25.5	108.1	46.6	3.94	33.2	3.47	25.4	106.3	47.0	3.84	33.9	3.59	25.3			
130		141.9	47.5	5.23	29.6	2.66	25.9	138.3	47.8	5.10	30.4	2.75	25.8	136.4	48.2	4.98	31.2	2.84	25.7			
140		Operation not recommended							148.4	48.2	5.84	28.3	2.42	26.1	146.5	48.6	5.70	29.2	2.50	26.0		
50	8	60	72.2	48.7	2.49	40.1	5.72	39.7	68.5	49.0	2.44	40.7	5.90	39.5	66.6	49.4	2.38	41.3	6.09	39.4		
		80	92.6	50.4	3.38	38.8	4.37	40.0	88.8	50.8	3.30	39.5	4.51	39.8	86.8	51.1	3.22	40.2	4.66	39.7		
		100	113.1	52.3	4.07	38.4	3.77	40.1	109.2	52.7	3.98	39.2	3.89	39.9	107.1	53.1	3.88	39.9	4.01	39.7		
		130	144.0	56.0	5.24	38.1	3.13	40.2	139.8	56.4	5.12	39.0	3.23	40.0	137.6	56.9	4.99	39.8	3.34	39.7		
		140	Operation not recommended							150.0	57.4	5.83	37.5	2.89	40.3	147.7	57.9	5.69	38.4	2.98	40.1	
	12	60	72.4	49.6	2.51	41.0	5.80	42.6	68.7	50.0	2.45	41.6	5.98	42.5	66.7	50.4	2.39	42.2	6.18	42.4		
		80	92.9	51.5	3.38	40.0	4.47	42.8	89.0	51.9	3.30	40.7	4.61	42.7	87.0	52.3	3.22	41.3	4.76	42.6		
		100	113.4	53.5	4.25	39.0	3.69	43.0	109.4	53.9	4.15	39.7	3.81	42.9	107.2	54.3	4.05	40.5	3.93	42.7		
		130	144.1	56.4	5.56	37.4	2.97	43.3	139.9	56.8	5.43	38.3	3.07	43.1	137.6	57.2	5.29	39.2	3.17	43.0		
		140	Operation not recommended							150.1	57.8	5.85	37.8	2.89	43.2	147.8	58.2	5.71	38.7	2.99	43.1	
	15	60	72.6	50.5	2.52	41.9	5.88	44.2	68.9	50.9	2.46	42.5	6.07	44.2	66.8	51.3	2.40	43.1	6.26	44.1		
		80	93.1	52.3	3.41	40.7	4.49	44.4	89.2	52.7	3.33	41.3	4.64	44.3	87.1	53.1	3.25	42.0	4.79	44.2		
100		113.5	54.1	4.10	40.1	3.87	44.5	109.5	54.5	4.00	40.8	3.99	44.4	107.3	54.9	3.90	41.6	4.13	44.3			
130		144.2	56.7	5.28	38.7	3.15	44.7	139.9	57.2	5.16	39.6	3.25	44.6	137.7	57.6	5.03	40.4	3.36	44.4			
140		Operation not recommended							150.1	58.2	5.87	38.1	2.90	44.8	147.8	58.6	5.73	39.0	3.00	44.6		
70	8	60	74.2	56.8	2.49	48.3	6.69	57.5	70.2	58.6	2.48	50.1	6.91	57.1	68.0	60.3	2.48	51.8	7.14	56.6		
		80	94.9	59.4	3.74	46.7	4.66	58.0	90.6	60.9	3.72	48.2	4.80	57.6	88.3	62.4	3.69	49.8	4.95	57.2		
		100	115.5	62.1	4.99	45.0	3.65	58.4	111.0	63.4	4.55	47.9	4.08	57.7	108.6	64.8	4.11	50.8	4.62	56.9		
		130	146.5	66.0	6.86	42.6	2.82	59.0	141.7	67.1	6.18	46.0	3.18	58.1	139.1	68.2	5.50	49.5	3.64	57.3		
		140	Operation not recommended							Operation not recommended							149.0	67.6	6.19	46.4	3.20	58.0
	12	60	74.7	58.7	2.47	50.3	6.97	61.0	70.4	60.1	2.48	51.6	7.11	60.7	68.2	61.4	2.49	53.0	7.24	60.5		
		80	95.4	61.7	3.73	49.0	4.85	61.2	90.9	62.4	3.58	50.2	5.11	61.0	88.4	63.1	3.42	51.4	5.41	60.8		
		100	116.2	64.7	5.00	47.7	3.80	61.5	111.3	64.7	4.67	48.8	4.06	61.3	108.6	64.7	4.35	49.9	4.36	61.1		
		130	147.3	69.2	6.89	45.7	2.94	61.8	141.9	68.2	6.32	46.6	3.16	61.6	139.0	67.2	5.75	47.6	3.43	61.5		
		140	Operation not recommended							Operation not recommended							149.1	68.0	6.21	46.8	3.21	61.6
	15	60	75.1	60.6	2.44	52.2	7.26	62.8	70.7	61.6	2.47	53.1	7.30	62.7	68.3	62.6	2.50	54.1	7.34	62.6		
		80	96.0	64.0	3.72	51.2	5.03	63.0	91.2	64.4	3.73	51.6	5.06	62.9	88.6	64.8	3.73	52.0	5.09	62.8		
100		116.8	67.4	5.00	50.3	3.94	63.1	111.7	67.2	4.57	51.6	4.31	62.9	108.9	67.0	4.14	52.8	4.75	62.7			
130		148.1	72.5	6.92	48.8	3.07	63.3	142.3	70.8	6.23	49.5	3.33	63.2	139.2	69.1	5.54	50.2	3.66	63.1			
140		Operation not recommended							Operation not recommended							149.1	68.4	6.24	47.2	3.22	63.5	
90	8	60	77.2	68.9	2.36	60.8	8.56	74.3	72.1	69.4	2.32	61.5	8.78	74.2	69.3	69.9	2.28	62.1	9.00	74.0		
		80	97.5	70.0	3.28	58.8	6.26	74.8	92.3	70.5	3.22	59.5	6.41	74.7	89.5	71.1	3.17	60.3	6.57	74.5		
		100	118.4	73.8	4.07	59.9	5.32	74.6	112.9	74.3	4.00	60.7	5.45	74.4	110.0	74.9	3.93	61.5	5.59	74.2		
		130	148.6	74.5	5.55	55.6	3.93	75.7	143.1	75.1	5.46	56.4	4.03	75.5	140.1	75.6	5.36	57.3	4.13	75.2		
		140	Operation not recommended																			
	12	60	77.5	70.2	2.37	62.1	8.68	78.9	72.3	70.7	2.33	62.8	8.90	78.7	69.5	71.3	2.29	63.4	9.13	78.6		
		80	98.7	74.8	4.04	61.1	5.43	79.1	92.9	73.9	3.66	61.4	5.91	79.0	89.7	72.9	3.29	61.7	6.51	78.9		
		100	119.9	79.5	5.71	60.0	4.08	79.2	113.4	77.1	5.00	60.0	4.52	79.2	110.0	74.6	4.28	60.0	5.11	79.2		
		130	151.6	86.5	8.22	58.4	3.08	79.5	144.2	81.8	7.00	57.9	3.43	79.6	140.3	77.2	5.78	57.4	3.91	79.7		
		140	Operation not recommended																			
	15	60	77.9	71.5	2.38	63.4	8.80	81.3	72.5	72.1	2.34	64.1	9.02	81.2	69.7	72.6	2.30	64.8	9.25	81.1		
		80	98.2	72.7	3.31	61.4	6.43	81.6	92.7	73.2	3.26	62.1	6.59	81.5	89.8	73.8	3.20	62.9	6.76	81.4		
100		119.1	76.2	4.09	62.3	5.46	81.4	113.4	76.8	4.02	63.1	5.60	81.3	110.3	77.4	3.95	63.9	5.74	81.2			
130		148.9	75.5	5.59	56.4	3.96	82.2	143.2	76.0	5.49	57.3	4.06	82.1	140.2	76.6	5.40	58.2	4.16	82.0			
140		Operation not recommended																				

# Performance Data cont.

## 050-Cooling

Source		Load Flow - 8 GPM							Load Flow - 12 GPM							Load Flow - 15 GPM						
EST °F	Flow GPM	ELT °F	LLT °F	TC MBTUH	Power kW	HR MBTUH	EER	LST °F	LLT °F	TC MBTUH	Power kW	HR MBTUH	EER	LST °F	LLT °F	TC MBTUH	Power kW	HR MBTUH	EER	LST °F		
50	8	50	38.9	44.4	2.27	52.1	19.6	63.0	42.2	45.1	2.27	52.8	19.8	63.2	43.9	45.7	2.27	53.5	20.1	63.4		
		70	58.1	47.7	2.30	55.6	20.7	63.9	61.6	48.4	2.30	56.3	21.0	64.1	63.5	49.1	2.30	57.0	21.3	64.2		
		90	77.2	51.1	2.33	59.0	21.9	64.8	81.0	51.8	2.33	59.7	22.2	64.9	83.0	52.5	2.33	60.5	22.5	65.1		
		110	96.4	54.4	2.37	62.5	23.0	65.6	100.4	55.1	2.36	63.2	23.3	65.8	102.5	55.9	2.36	64.0	23.7	66.0		
	12	50	39.1	43.7	2.25	51.4	19.4	58.9	42.3	44.2	2.26	51.9	19.6	59.0	44.0	44.8	2.26	52.5	19.8	59.1		
		70	58.2	47.1	2.27	54.8	20.7	59.5	61.7	47.7	2.27	55.4	21.0	59.6	63.6	48.3	2.27	56.0	21.2	59.7		
		90	77.4	50.4	2.28	58.2	22.1	60.1	81.1	51.1	2.28	58.9	22.4	60.2	83.1	51.8	2.28	59.6	22.7	60.4		
		110	96.5	53.8	2.30	61.7	23.4	60.7	100.5	54.5	2.30	62.4	23.7	60.8	102.6	55.3	2.30	63.1	24.1	61.0		
	15	50	39.3	43.0	2.24	50.6	19.2	56.7	42.4	43.4	2.25	51.1	19.3	56.8	44.1	43.9	2.25	51.6	19.5	56.9		
		70	58.4	46.4	2.24	54.0	20.7	57.2	61.8	46.9	2.24	54.6	20.9	57.3	63.7	47.5	2.24	55.1	21.2	57.4		
		90	77.5	49.8	2.24	57.4	22.3	57.7	81.2	50.4	2.24	58.1	22.5	57.7	83.2	51.0	2.24	58.7	22.8	57.8		
		110	96.7	53.2	2.23	60.9	23.8	58.1	100.6	53.9	2.23	61.5	24.2	58.2	102.7	54.6	2.23	62.2	24.5	58.3		
70	8	50	40.2	39.1	2.69	48.3	14.5	82.1	43.1	39.7	2.69	48.9	14.7	82.2	44.6	40.3	2.69	49.5	15.0	82.4		
		70	58.6	45.5	2.74	54.8	16.6	83.7	62.0	46.1	2.74	55.5	16.8	83.9	63.8	46.8	2.74	56.1	17.1	84.0		
		90	77.0	51.9	2.79	61.4	18.6	85.4	80.9	52.6	2.79	62.1	18.8	85.5	82.9	53.2	2.79	62.8	19.1	85.7		
		110	95.4	58.3	2.85	68.0	20.5	87.0	99.7	59.0	2.84	68.7	20.7	87.2	102.0	59.7	2.84	69.4	21.0	87.3		
	12	50	40.3	38.6	2.68	47.7	14.4	78.3	43.2	39.2	2.68	48.3	14.6	78.4	44.7	39.7	2.68	48.8	14.8	78.5		
		70	58.7	45.1	2.70	54.3	16.7	79.4	62.1	45.7	2.71	54.9	16.9	79.6	63.8	46.3	2.71	55.5	17.1	79.7		
		90	77.1	51.6	2.73	60.9	18.9	80.6	80.9	52.2	2.73	61.6	19.1	80.7	82.9	52.9	2.73	62.2	19.3	80.8		
		110	95.5	58.0	2.76	67.5	21.0	81.7	99.8	58.8	2.76	68.2	21.3	81.9	102.1	59.5	2.76	68.9	21.5	82.0		
	15	50	40.5	38.1	2.66	47.2	14.3	76.3	43.3	38.6	2.66	47.7	14.5	76.4	44.8	39.1	2.67	48.2	14.7	76.4		
		70	58.8	44.7	2.67	53.8	16.8	77.2	62.1	45.3	2.67	54.4	17.0	77.2	63.9	45.8	2.67	55.0	17.2	77.3		
		90	77.2	51.3	2.67	60.4	19.2	78.0	81.0	51.9	2.67	61.0	19.4	78.1	83.0	52.6	2.68	61.7	19.6	78.2		
		110	95.5	57.8	2.68	67.0	21.6	78.9	99.8	58.6	2.68	67.7	21.9	79.0	102.1	59.3	2.68	68.5	22.1	79.1		
90	8	50	41.5	33.8	3.12	44.4	10.8	101.1	44.0	34.4	3.11	45.0	11.0	101.2	45.3	34.9	3.11	45.5	11.2	101.4		
		70	59.2	43.2	3.18	54.1	13.6	103.5	62.4	43.8	3.18	54.7	13.8	103.7	64.1	44.4	3.18	55.3	14.0	103.8		
		90	76.8	52.7	3.25	63.8	16.2	105.9	80.7	53.3	3.25	64.4	16.4	106.1	82.8	54.0	3.25	65.1	16.6	106.3		
		110	94.5	62.1	3.32	73.5	18.7	108.4	99.1	62.8	3.32	74.1	18.9	108.5	101.5	63.5	3.32	74.8	19.1	108.7		
	12	50	41.6	33.5	3.10	44.1	10.8	97.7	44.1	34.1	3.10	44.6	11.0	97.8	45.4	34.6	3.10	45.2	11.2	97.9		
		70	59.2	43.1	3.14	53.8	13.7	99.4	62.4	43.7	3.14	54.4	13.9	99.5	64.1	44.3	3.14	55.0	14.1	99.6		
		90	76.8	52.7	3.18	63.5	16.6	101.1	80.7	53.4	3.18	64.2	16.8	101.2	82.8	54.0	3.18	64.9	17.0	101.3		
		110	94.4	62.3	3.22	73.3	19.3	102.7	99.0	63.0	3.22	74.0	19.5	102.9	101.5	63.7	3.23	74.8	19.8	103.0		
	15	50	41.7	33.3	3.08	43.8	10.8	95.8	44.1	33.8	3.08	44.3	11.0	95.9	45.4	34.3	3.08	44.8	11.1	96.0		
		70	59.3	43.0	3.09	53.5	13.9	97.1	62.4	43.6	3.10	54.2	14.1	97.2	64.1	44.2	3.10	54.8	14.3	97.3		
		90	76.8	52.7	3.11	63.3	17.0	98.4	80.7	53.4	3.11	64.0	17.2	98.5	82.8	54.1	3.12	64.7	17.4	98.6		
		110	94.4	62.4	3.12	73.1	20.0	99.7	99.0	63.2	3.13	73.9	20.2	99.8	101.5	64.0	3.14	74.7	20.4	100.0		
110	8	50	42.9	28.5	3.54	40.6	8.1	120.1	45.0	29.0	3.54	41.1	8.2	120.3	46.1	29.5	3.53	41.5	8.4	120.4		
		70	59.8	41.0	3.63	53.4	11.3	123.3	62.8	41.6	3.62	53.9	11.5	123.5	64.4	42.1	3.62	54.5	11.6	123.6		
		90	76.6	53.5	3.71	66.2	14.4	126.5	80.6	54.1	3.71	66.8	14.6	126.7	82.7	54.7	3.71	67.4	14.7	126.8		
		110	93.5	66.0	3.80	79.0	17.4	129.7	98.4	66.7	3.80	79.6	17.5	129.9	101.0	67.3	3.80	80.3	17.7	130.1		
	12	50	42.9	28.5	3.52	40.5	8.1	117.0	45.0	29.0	3.52	41.0	8.2	117.1	46.1	29.5	3.52	41.5	8.4	117.2		
		70	59.7	41.1	3.57	53.3	11.5	119.3	62.7	41.7	3.57	53.9	11.7	119.4	64.4	42.3	3.57	54.5	11.8	119.5		
		90	76.5	53.8	3.63	66.2	14.8	121.5	80.5	54.5	3.63	66.9	15.0	121.6	82.6	55.2	3.63	67.6	15.2	121.8		
		110	93.4	66.5	3.68	79.1	18.1	123.7	98.3	67.2	3.69	79.8	18.2	123.9	100.9	68.0	3.69	80.6	18.4	124.0		
	15	50	42.9	28.4	3.50	40.4	8.1	115.4	45.0	29.0	3.50	40.9	8.3	115.5	46.1	29.5	3.50	41.4	8.4	115.5		
		70	59.7	41.3	3.52	53.3	11.7	117.1	62.7	41.9	3.53	53.9	11.9	117.2	64.3	42.6	3.53	54.6	12.1	117.3		
		90	76.5	54.1	3.54	66.2	15.3	118.8	80.5	54.9	3.55	67.0	15.5	118.9	82.6	55.6	3.56	67.8	15.6	119.0		
		110	93.3	67.0	3.56	79.1	18.8	120.6	98.2	67.8	3.57	80.0	19.0	120.7	100.8	68.7	3.59	80.9	19.1	120.8		

# Performance Data cont.

## 066-Heating

Source		Load Flow - 10 GPM							Load Flow - 15 GPM							Load Flow - 20 GPM						
EST °F	Flow GPM	ELT °F	LLT °F	HC MBTUH	Power kW	HE MBTUH	COP	LST °F	LLT °F	HC MBTUH	Power kW	HE MBTUH	COP	LST °F	LLT °F	HC MBTUH	Power kW	HE MBTUH	COP	LST °F		
30	10	60	70.6	53.2	3.05	42.8	5.12	21.2	67.1	53.6	2.98	43.5	5.28	21.0	65.4	54.0	2.90	44.1	5.45	20.9		
		80	90.8	54.1	3.96	40.6	4.00	21.6	87.3	54.5	3.87	41.3	4.13	21.5	85.5	54.9	3.77	42.0	4.27	21.3		
		100	111.0	55.2	5.14	37.7	3.15	22.2	107.4	55.6	5.02	38.5	3.25	22.1	105.6	56.0	4.90	39.3	3.36	21.9		
		130	141.5	57.7	6.88	34.2	2.46	23.0	137.7	58.1	6.72	35.2	2.54	22.7	135.9	58.5	6.55	36.2	2.62	22.5		
		140	Operation not recommended							147.8	58.5	7.51	32.9	2.28	23.2	145.9	58.9	7.33	33.9	2.36	23.0	
	15	60	70.8	54.2	3.06	43.8	5.19	24.0	67.3	54.6	2.99	44.4	5.36	23.9	65.5	55.1	2.92	45.1	5.53	23.8		
		80	91.1	55.3	4.23	40.9	3.83	24.4	87.4	55.7	4.13	41.6	3.96	24.3	85.6	56.1	4.03	42.4	4.09	24.2		
		100	111.3	56.3	5.39	37.9	3.06	24.8	107.6	56.8	5.26	38.8	3.16	24.7	105.7	57.2	5.14	39.7	3.26	24.5		
		130	141.6	57.9	7.14	33.5	2.38	25.4	137.8	58.3	6.97	34.6	2.45	25.2	135.9	58.8	6.80	35.6	2.53	25.1		
		140	Operation not recommended							147.9	58.9	7.54	33.2	2.29	25.4	145.9	59.3	7.35	34.2	2.36	25.3	
	20	60	71.1	55.3	3.08	44.8	5.26	25.4	67.4	55.7	3.01	45.4	5.43	25.3	65.6	56.1	2.93	46.1	5.61	25.2		
		80	91.2	56.1	4.00	42.5	4.11	25.6	87.5	56.6	3.91	43.2	4.25	25.5	85.7	57.0	3.81	44.0	4.38	25.5		
		100	111.4	57.0	5.17	39.4	3.24	25.9	107.7	57.5	5.04	40.3	3.34	25.8	105.8	57.9	4.92	41.1	3.45	25.8		
		130	141.7	58.4	6.93	34.8	2.47	26.4	137.8	58.9	6.77	35.8	2.55	26.3	135.9	59.3	6.60	36.8	2.63	26.2		
		140	Operation not recommended							147.9	59.3	7.56	33.4	2.30	26.6	146.0	59.7	7.38	34.5	2.37	26.4	
50	10	60	72.8	64.2	3.10	53.6	6.08	38.9	68.6	64.7	3.02	54.4	6.27	38.8	66.5	65.2	2.95	55.1	6.48	38.6		
		80	93.3	66.4	4.11	52.4	4.74	39.2	88.9	66.9	4.01	53.2	4.89	39.0	86.7	67.4	3.91	54.1	5.05	38.9		
		100	113.6	67.9	5.38	49.5	3.70	39.8	109.1	68.4	5.25	50.5	3.82	39.6	106.9	68.9	5.12	51.4	3.94	39.4		
		130	144.0	70.0	7.09	45.8	2.89	40.6	139.4	70.6	6.92	46.9	2.99	40.3	137.1	71.1	6.75	48.0	3.09	40.1		
		140	Operation not recommended							149.5	71.3	7.73	45.0	2.71	40.7	147.2	71.9	7.54	46.2	2.79	40.5	
	15	60	73.1	65.5	3.11	54.8	6.16	42.5	68.8	65.9	3.04	55.6	6.36	42.4	66.6	66.4	2.97	56.3	6.57	42.3		
		80	93.4	66.9	4.32	52.2	4.54	42.8	89.0	67.4	4.22	53.0	4.68	42.7	86.8	67.9	4.11	53.9	4.84	42.6		
		100	113.7	68.4	5.53	49.5	3.62	43.2	109.2	68.9	5.40	50.5	3.74	43.1	106.9	69.4	5.26	51.4	3.86	42.9		
		130	144.1	70.5	7.34	45.5	2.82	43.7	139.5	71.1	7.16	46.6	2.91	43.6	137.2	71.6	6.99	47.8	3.00	43.4		
		140	Operation not recommended							149.6	71.8	7.75	45.3	2.71	43.8	147.2	72.3	7.56	46.5	2.80	43.6	
	20	60	73.3	66.7	3.13	56.0	6.25	44.2	69.0	67.2	3.05	56.8	6.45	44.1	66.8	67.7	2.98	57.5	6.66	44.1		
		80	93.8	69.0	4.15	54.8	4.87	44.4	89.3	69.5	4.05	55.7	5.03	44.3	87.0	70.0	3.95	56.5	5.19	44.2		
		100	114.0	70.1	5.41	51.7	3.80	44.7	109.4	70.7	5.28	52.7	3.92	44.6	107.1	71.2	5.15	53.6	4.05	44.5		
		130	144.2	70.9	7.14	46.6	2.91	45.2	139.5	71.5	6.97	47.7	3.00	45.1	137.2	72.0	6.80	48.8	3.10	45.0		
		140	Operation not recommended							149.6	72.3	7.78	45.7	2.72	45.3	147.3	72.8	7.59	46.9	2.81	45.2	
70	10	60	74.2	70.8	3.11	60.2	6.67	57.6	69.9	74.1	3.05	63.7	7.12	56.9	67.7	77.3	2.99	67.1	7.59	56.2		
		80	94.3	71.3	4.43	56.2	4.72	58.4	90.0	75.0	4.30	60.3	5.12	57.6	87.9	78.7	4.17	64.5	5.54	56.7		
		100	114.4	71.8	5.74	52.2	3.66	59.2	110.2	76.2	5.56	57.2	4.02	58.2	108.1	80.5	5.37	62.2	4.39	57.2		
		130	144.5	72.5	7.71	46.2	2.76	60.5	140.5	78.4	7.42	53.1	3.10	59.1	138.4	84.3	7.14	59.9	3.46	57.6		
		140	Operation not recommended							Operation not recommended							148.5	85.0	7.73	58.6	3.22	57.9
	15	60	74.8	74.2	3.13	63.5	6.95	61.3	70.2	76.5	3.07	66.0	7.31	60.9	67.9	78.8	3.00	68.6	7.69	60.6		
		80	95.0	74.9	4.46	59.6	4.92	61.8	90.4	77.7	4.32	62.9	5.26	61.4	88.0	80.5	4.19	66.2	5.63	60.9		
		100	115.1	75.5	5.79	55.8	3.82	62.3	110.5	78.9	5.58	59.8	4.14	61.8	108.2	82.2	5.38	63.8	4.48	61.2		
		130	145.3	76.6	7.79	50.0	2.88	63.1	140.8	80.6	7.47	55.1	3.16	62.4	138.5	84.7	7.16	60.3	3.47	61.7		
		140	Operation not recommended							Operation not recommended							148.6	85.6	7.75	59.1	3.23	61.9
	20	60	75.5	77.5	3.14	66.8	7.23	63.1	70.5	78.9	3.08	68.4	7.51	62.9	68.0	80.3	3.02	70.0	7.80	62.8		
		80	95.7	78.4	4.49	63.1	5.12	63.5	90.7	80.1	4.35	65.2	5.40	63.3	88.2	81.8	4.21	67.4	5.69	63.1		
		100	115.9	79.3	5.84	59.4	3.98	63.9	110.8	81.3	5.62	62.1	4.24	63.6	108.3	83.2	5.40	64.8	4.52	63.3		
		130	146.1	80.7	7.86	53.8	3.01	64.5	141.1	83.0	7.52	57.3	3.23	64.1	138.5	85.4	7.19	60.9	3.48	63.7		
		140	Operation not recommended							Operation not recommended							148.6	86.1	7.78	59.6	3.24	63.9
90	10	60	77.3	86.3	3.14	75.6	8.04	74.4	71.6	87.0	3.09	76.4	8.25	74.2	68.8	87.6	3.04	77.3	8.45	74.1		
		80	98.6	93.0	4.03	79.2	6.77	73.7	92.5	93.7	3.96	80.2	6.93	73.5	89.4	94.4	3.89	81.1	7.11	73.3		
		100	119.2	95.8	5.05	78.6	5.57	73.8	112.9	96.6	4.96	79.6	5.70	73.6	109.7	97.3	4.88	80.6	5.85	73.4		
		130	149.5	97.7	7.14	73.4	4.01	74.9	143.1	98.5	7.02	74.5	4.11	74.6	139.9	99.2	6.90	75.7	4.21	74.4		
		140	Operation not recommended							Operation not recommended							Operation not recommended					
	15	60	77.6	88.0	3.16	77.2	8.16	79.4	71.8	88.6	3.11	78.0	8.36	79.3	68.9	89.3	3.05	78.9	8.57	79.2		
		80	97.6	88.2	4.64	72.4	5.58	80.1	91.9	89.6	4.46	74.4	5.89	79.8	89.1	91.0	4.28	76.3	6.22	79.5		
		100	117.7	88.4	6.11	67.5	4.24	80.7	112.1	90.5	5.81	70.7	4.56	80.3	109.3	92.6	5.51	73.8	4.92	79.9		
		130	147.7	88.7	8.32	60.3	3.12	81.7	142.3	91.9	7.84	65.1	3.44	81.0	139.5	95.1	7.36	70.0	3.79	80.4		
		140	Operation not recommended							Operation not recommended							Operation not recommended					
	20	60	77.9	89.6	3.18	78.8	8.27	81.9	72.0	90.3	3.12	79.7	8.48	81.8	69.1	91.0	3.07	80.5	8.69	81.7		
		80	99.3	96.5	4.07	82.7	6.96	81.5	93.0	97.3	4.00	83.6	7.13	81.4	89.8	98.0	3.93	84.6	7.31	81.3		
		100	119.8	99.0	5.07	81.7	5.72	81.6	113.3	99.7	4.99	82.7	5.86	81.5	110.1	100.5	4.90	83.8	6.01	81.4		
		130	149.8	99.0	7.19	74.4	4.03	82.3	143.3	99.7	7.07	75.6	4.13	82.2	140.1	100.5	6.95	76.8	4.24	82.1		
		140	Operation not recommended							Operation not recommended							Operation not recommended					

# Performance Data cont.

## 066-Cooling

Source		Load Flow - 10 GPM							Load Flow - 15 GPM							Load Flow - 20 GPM						
EST °F	Flow GPM	ELT °F	LLT °F	TC MBTUH	Power kW	HR MBTUH	EER	LST °F	LLT °F	TC MBTUH	Power kW	HR MBTUH	EER	LST °F	LLT °F	TC MBTUH	Power kW	HR MBTUH	EER	LST °F		
50	10	50	39.8	51.1	2.98	61.3	17.2	62.3	43.1	51.8	2.99	62.1	17.3	62.4	44.7	52.6	3.00	62.8	17.5	62.6		
		70	58.9	55.3	3.02	65.6	18.3	63.1	62.5	55.9	3.03	66.3	18.4	63.3	64.3	56.5	3.04	66.9	18.6	63.4		
		90	78.1	59.5	3.07	69.9	19.4	64.0	82.0	60.0	3.07	70.5	19.5	64.1	84.0	60.5	3.07	71.0	19.7	64.2		
		110	97.3	63.7	3.11	74.3	20.4	64.9	101.5	64.0	3.11	74.7	20.6	64.9	103.6	64.4	3.11	75.0	20.7	65.0		
	15	50	40.0	50.0	2.90	59.8	17.2	58.0	43.2	50.7	2.91	60.6	17.4	58.1	44.9	51.4	2.92	61.4	17.6	58.2		
		70	59.2	53.8	2.93	63.8	18.4	58.5	62.7	54.4	2.94	64.4	18.5	58.6	64.5	55.0	2.94	65.1	18.7	58.7		
		90	78.5	57.6	2.96	67.7	19.5	59.0	82.2	58.1	2.97	68.3	19.6	59.1	84.1	58.7	2.97	68.8	19.7	59.2		
		110	97.7	61.5	2.99	71.7	20.6	59.6	101.8	61.9	2.99	72.1	20.7	59.6	103.8	62.3	3.00	72.5	20.8	59.7		
	20	50	40.2	48.8	2.82	58.4	17.3	55.8	43.4	49.5	2.82	59.2	17.5	55.9	45.0	50.3	2.83	59.9	17.7	56.0		
		70	59.5	52.3	2.83	61.9	18.4	56.2	62.9	52.9	2.84	62.6	18.6	56.3	64.6	53.6	2.85	63.3	18.8	56.3		
		90	78.8	55.8	2.85	65.5	19.6	56.6	82.5	56.3	2.86	66.1	19.7	56.6	84.3	56.8	2.87	66.6	19.8	56.7		
		110	98.1	59.3	2.87	69.1	20.7	56.9	102.0	59.7	2.88	69.5	20.7	57.0	104.0	60.1	2.89	70.0	20.8	57.0		
70	10	50	40.4	47.8	3.68	60.4	13.0	82.1	43.5	48.7	3.70	61.4	13.2	82.3	45.0	49.7	3.72	62.4	13.4	82.5		
		70	59.3	53.7	3.76	66.6	14.3	83.3	62.7	54.5	3.77	67.4	14.5	83.5	64.5	55.4	3.78	68.3	14.6	83.7		
		90	78.1	59.6	3.83	72.7	15.6	84.5	82.0	60.3	3.84	73.5	15.7	84.7	83.9	61.1	3.85	74.2	15.9	84.8		
		110	96.9	65.5	3.91	78.9	16.8	85.8	101.2	66.1	3.91	79.5	16.9	85.9	103.3	66.7	3.92	80.1	17.0	86.0		
	15	50	40.6	47.1	3.59	59.4	13.1	77.9	43.6	48.1	3.61	60.4	13.3	78.1	45.1	49.0	3.62	61.4	13.5	78.2		
		70	59.4	52.8	3.65	65.2	14.5	78.7	62.9	53.6	3.66	66.1	14.6	78.8	64.6	54.4	3.67	67.0	14.8	78.9		
		90	78.3	58.4	3.70	71.0	15.8	79.5	82.1	59.1	3.71	71.8	15.9	79.6	84.0	59.8	3.72	72.5	16.1	79.7		
		110	97.2	64.0	3.76	76.9	17.0	80.2	101.4	64.6	3.77	77.5	17.1	80.3	103.5	65.2	3.78	78.1	17.3	80.4		
	20	50	40.7	46.5	3.50	58.4	13.3	75.8	43.7	47.4	3.51	59.4	13.5	75.9	45.2	48.4	3.53	60.5	13.7	76.0		
		70	59.6	51.8	3.54	63.9	14.6	76.4	63.0	52.7	3.55	64.8	14.8	76.5	64.7	53.5	3.56	65.6	15.0	76.6		
		90	78.6	57.2	3.57	69.4	16.0	76.9	82.3	57.9	3.59	70.1	16.1	77.0	84.1	58.6	3.60	70.8	16.3	77.1		
		110	97.5	62.5	3.61	74.9	17.3	77.5	101.6	63.1	3.62	75.4	17.4	77.5	103.6	63.6	3.64	76.0	17.5	77.6		
90	10	50	41.1	44.5	4.39	59.5	10.2	101.9	43.9	45.6	4.41	60.7	10.4	102.1	45.3	46.8	4.43	61.9	10.5	102.4		
		70	59.6	52.2	4.49	67.5	11.6	103.5	62.9	53.2	4.51	68.6	11.8	103.7	64.6	54.2	4.53	69.7	12.0	103.9		
		90	78.0	59.8	4.60	75.5	13.0	105.1	81.9	60.7	4.61	76.4	13.2	105.3	83.8	61.6	4.63	77.4	13.3	105.5		
		110	96.5	67.4	4.70	83.5	14.3	106.7	100.9	68.3	4.71	84.3	14.5	106.9	103.1	69.1	4.72	85.2	14.6	107.0		
	15	50	41.1	44.3	4.29	59.0	10.3	97.9	43.9	45.5	4.31	60.2	10.6	98.0	45.3	46.7	4.33	61.4	10.8	98.2		
		70	59.6	51.8	4.37	66.7	11.9	98.9	63.0	52.8	4.38	67.7	12.0	99.0	64.6	53.8	4.40	68.8	12.2	99.2		
		90	78.2	59.2	4.45	74.4	13.3	99.9	82.0	60.1	4.46	75.3	13.5	100.0	83.9	60.9	4.48	76.2	13.6	100.2		
		110	96.7	66.6	4.53	82.1	14.7	100.9	101.0	67.4	4.54	82.8	14.8	101.0	103.2	68.1	4.55	83.6	15.0	101.1		
	20	50	41.2	44.1	4.19	58.4	10.5	95.8	44.0	45.4	4.20	59.7	10.8	96.0	45.3	46.6	4.22	61.0	11.0	96.1		
		70	59.7	51.4	4.24	65.8	12.1	96.6	63.0	52.4	4.26	66.9	12.3	96.7	64.7	53.4	4.27	68.0	12.5	96.8		
		90	78.3	58.6	4.30	73.2	13.6	97.3	82.1	59.4	4.31	74.1	13.8	97.4	84.0	60.3	4.33	75.0	13.9	97.5		
		110	96.8	65.8	4.35	80.7	15.1	98.1	101.1	66.5	4.37	81.4	15.2	98.1	103.3	67.1	4.38	82.1	15.3	98.2		
110	10	50	41.8	41.2	5.09	58.6	8.1	121.7	44.3	42.5	5.12	60.0	8.3	122.0	45.6	43.9	5.15	61.4	8.5	122.3		
		70	59.9	50.6	5.22	68.4	9.7	123.7	63.1	51.8	5.25	69.7	9.9	123.9	64.7	53.0	5.28	71.0	10.1	124.2		
		90	78.0	60.0	5.36	78.3	11.2	125.7	81.9	61.1	5.38	79.4	11.4	125.9	83.8	62.2	5.40	80.6	11.5	126.1		
		110	96.1	69.3	5.50	88.1	12.6	127.6	100.6	70.4	5.51	89.2	12.8	127.8	102.9	71.4	5.53	90.2	12.9	128.0		
	15	50	41.7	41.5	4.98	58.5	8.3	117.8	44.3	42.9	5.01	60.0	8.6	118.0	45.6	44.3	5.03	61.5	8.8	118.2		
		70	59.9	50.7	5.09	68.1	10.0	119.1	63.1	52.0	5.11	69.4	10.2	119.3	64.7	53.2	5.13	70.7	10.4	119.4		
		90	78.0	60.0	5.19	77.7	11.6	120.4	81.9	61.0	5.21	78.8	11.7	120.5	83.8	62.1	5.23	79.9	11.9	120.7		
		110	96.2	69.2	5.30	87.3	13.1	121.6	100.7	70.1	5.31	88.2	13.2	121.8	102.9	71.0	5.33	89.2	13.3	121.9		
	20	50	41.6	41.8	4.87	58.4	8.6	115.8	44.2	43.3	4.89	60.0	8.8	116.0	45.5	44.8	4.91	61.5	9.1	116.2		
		70	59.8	50.9	4.95	67.8	10.3	116.8	63.0	52.1	4.97	69.1	10.5	116.9	64.7	53.4	4.98	70.4	10.7	117.0		
		90	78.0	60.0	5.02	77.1	11.9	117.7	81.9	61.0	5.04	78.2	12.1	117.8	83.8	62.0	5.06	79.2	12.3	117.9		
		110	96.2	69.1	5.10	86.4	13.6	118.6	100.7	69.8	5.11	87.3	13.7	118.7	102.9	70.6	5.13	88.1	13.8	118.8		

# Wiring Schematics

## Aurora Advanced EVI Water-Water 208-230/60/1

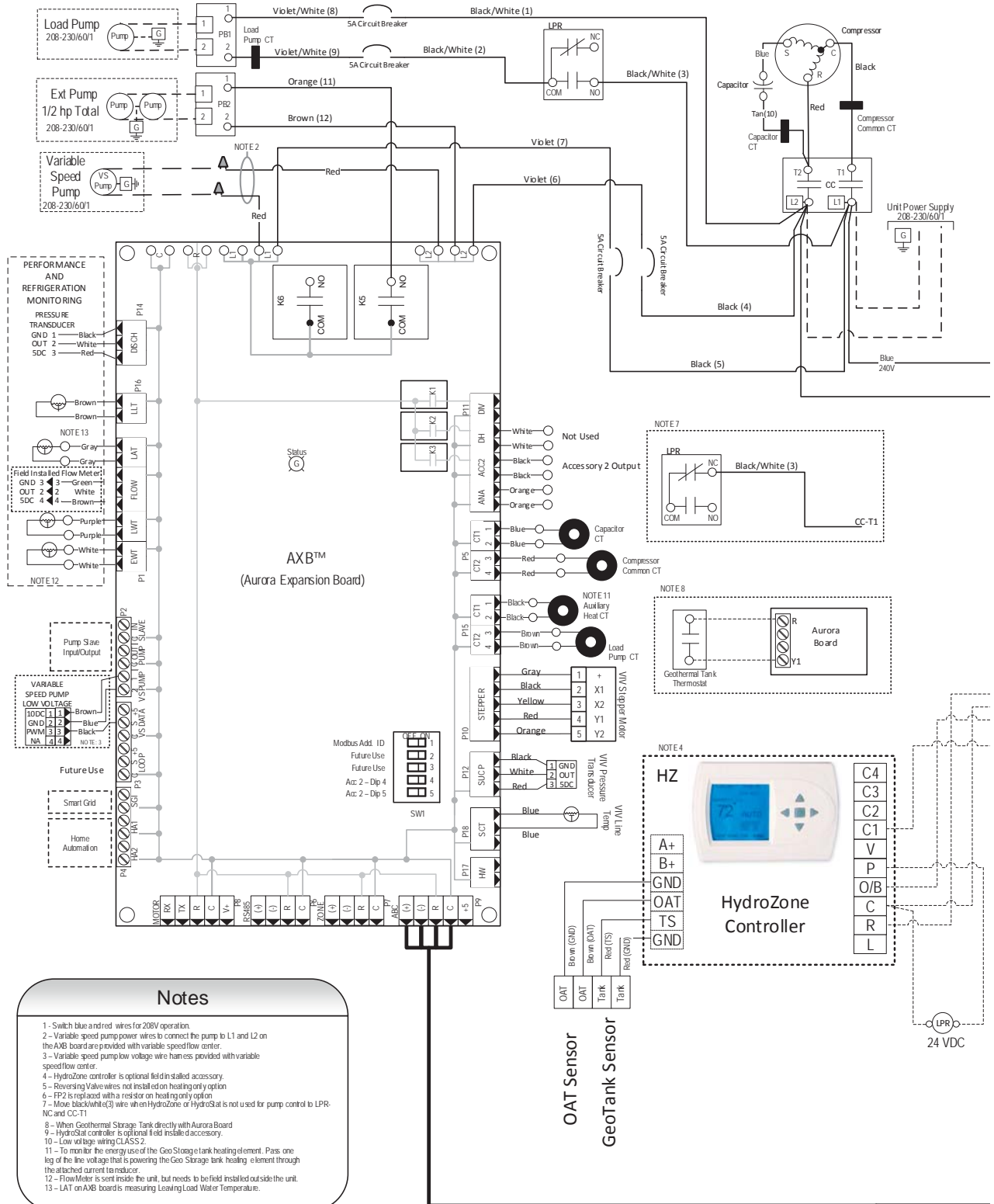

# Wiring Schematics

## Aurora Advanced EVI Water-Water 208-230/60/1

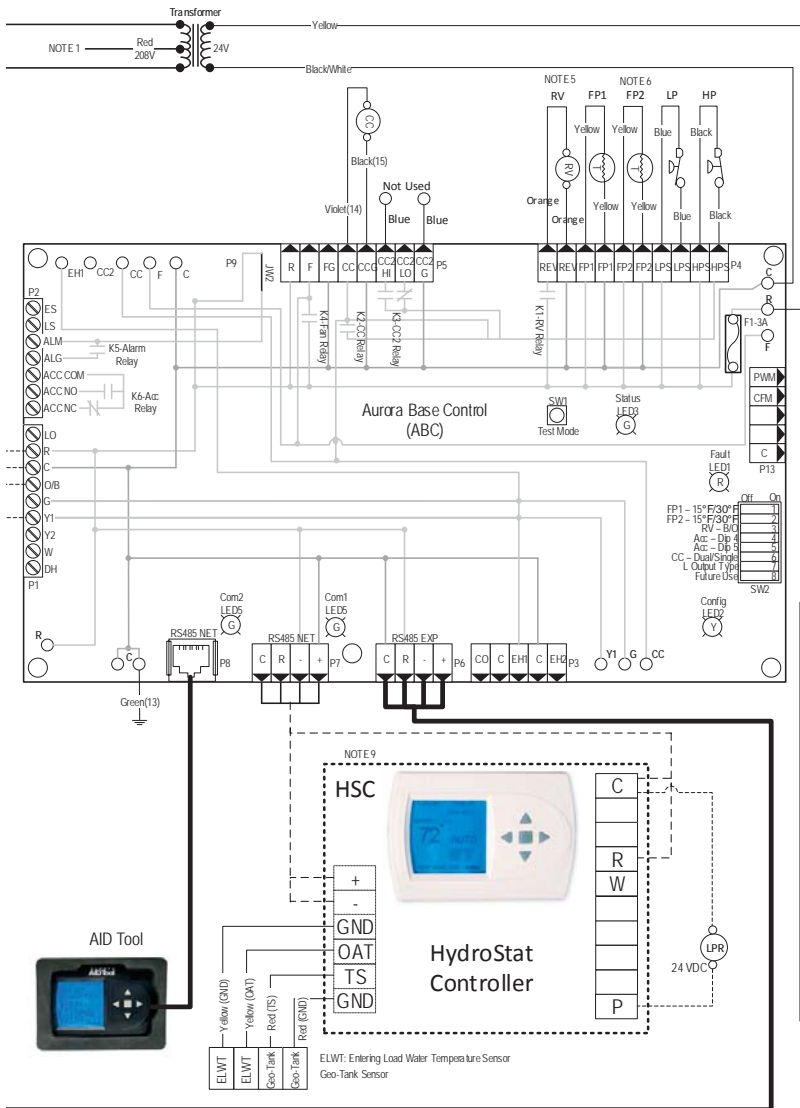
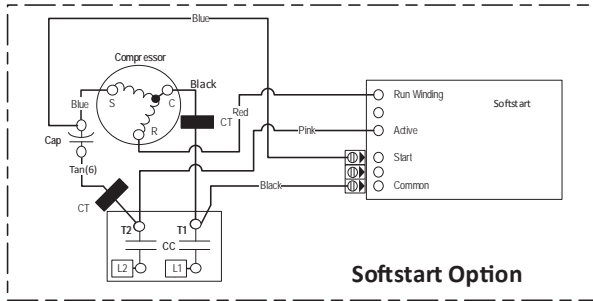

Aurora LED Flash Codes		
Slow Flash	1 second on and 1 second off	
Fast Flash	100 milliseconds on and 100 milliseconds off	
Flash Code	100 milliseconds on and 400 milliseconds off with a 2 second pause before repeating	
Random Start Delay (Alternating Colors)	Configuration LED (LED2, Yellow)	
Status LED (LED1, Green)	Fast Flash	No Software Override
Configuration LED (LED2, Yellow)	Fast Flash	DP Switch Override
Fault LED (LED3, Red)	Fast Flash	Slow Flash
Fault LED (LED1, Red)		
Normal Mode	OFF	Normal Mode
Input Fault Lockout	Flash Code 1	Control Is Non-Functional
High Pressure Lockout	Flash Code 2	Test Mode
Low Pressure Lockout	Flash Code 3	Lockout Active
Future Use	Flash Code 4	Dehumidification Mode
Freeze Detection - FP1	Flash Code 5	Future Use
Reserved	Flash Code 6	Future Use
Condensate Overflow Lockout	Flash Code 7	Load Shed
Over/Under Voltage Shutdown	Flash Code 8	ESD
Future Use	Flash Code 9	On Peak Mode
Compressor Monitor	Flash Code 10	Flash Code 7
FP1 Sensor Error	Flash Code 11	

ABC SW2 Accessory Relay		
DESCRIPTION	SW2-4	SW2-5
Cycle with Blower	ON	ON
Cycle with Compressor	OFF	OFF
Water Valve Slow Opening	ON	ON
Cycle with Comm. T-stat Hum Cmd	OFF	ON

Aurora Timing Events		
Event	Normal Mode	Test Mode
Random Start Delay	5 to 80 seconds	1 second
Compressor On Delay	5 seconds	< 1 second
Compressor Minimum On Time	2 minutes	30 seconds
Compressor Short Cycle Delay	4 minutes	15 seconds
Fault Recognition Delay - High Pressure	Less than 1 second	Less than 1 second
Start-Up Bypass - Low Pressure	2 minutes	30 seconds
Fault Recognition Delay - Low Pressure	30 seconds	30 seconds
Start-Up Bypass - Low Water Coil Limit	2 minutes	30 seconds
Fault Recognition Delay - Low Water Coil Limit	30 seconds	30 seconds
Fault Recognition Delay - Condensate Overflow	30 seconds	30 seconds
HydroZone Call Recognition Time	2 seconds	2 seconds
Water Valve Slow Open Delay	90 seconds	90 seconds

**Legend**

- Field Installed Item
- Factory Low voltage wiring
- Factory Line voltage wiring
- Field line voltage wiring
- Optional block
- DC Voltage PCB traces
- Junction
- Quick connect terminal
- Wire nut
- Field wire lug
- Ground
- Relay Contacts- N.O., N.C.
- Fuse
- Breaker
- Thermistor
- Light emitting diode - Green
- Relay coil
- Capacitor w/ bleed resistor
- Switch - Condensate overflow
- Switch - High pressure
- Switch - Low pressure
- Polarized connector
- Current Transducer (CT)

CC - Compressor Contactor  
CO - Condensate overflow sensor  
K6 - DHW pump relay  
K5 - Loop pump relay  
HP - High pressure switch  
LP - Low pressure switch  
VV - Vapor Injection Valve  
LPR - Load Pump Relay

PB1, PB2 - Power blocks  
RV - Reversing Valve coil  
SW1 - DIP package 5 position AXB  
SW1 - TEST MODE ABC Board  
SW2 - DIP package 5 position ABC Board  
OAT - Outdoor Air Temperature



## Accessories and Options

### IntelliStart (Model 040 only)

IntelliStart is a single phase compressor soft starter which reduces the normal start current (LRA) by 60-70%. It should be used in applications that require low starting amps, reduced compressor start-up noise, off-grid, and improved start-up behavior. IntelliStart is available as a factory installed option or a field installed kit. IntelliStart is available on 208-230/60/1 voltage.

### Water Connection Kits (Field Installed)

Water connection kits are available to facilitate loop side and load side water connections.

- **MA4FPT** - Forged brass 1" MPT x 1" FPT square street elbow with P/T plug for NEW040 water side connections
- **MA5FPT** - Forged brass 1.25" MPT x 1.25" FPT square street elbow with P/T plug for NEW050-NEW066 water side connections
- **WFI-HKM-100-24-MO** - 1 inch x 24 inch stainless steel braided hose kit
- **WFI-HKM-125-24-MO** - 1 1/4 inch x 24 inch stainless steel braided hose kit

### Earth Loop Pump Kit (Field Installed)

A specially designed one or two-pump module provides all liquid flow, fill and connection requirements for independent single unit systems (230/60/1 only). The one-pump module (FC1-FPT or FC1-GL) is capable of 25 feet of head at 12.0 GPM, while the two-pump module (FC2-FPT or FC1-GL) is capable of 50 feet of head at 12.0 GPM.

### Load-side Pump Kit (Field Installed)

Four (4) load pump kits are available to provide all liquid flow requirements for independent single unit systems (230/60/1 only). WaterFurnace part number **24S516-10** (Grundfos UPS15-42RU) is a composite body pump. **EWPK2** (Grundfos UP26-99SF) is stainless steel body pump. WaterFurnace part number EWPK1 and EWPK3 come with a cast iron body pump (Grundfos UP26-99F) that can be used for hydronic heating applications.

Calculate the system pressure drop then refer to the pump curves in figure 8 to select the proper pump. All four (4) of the WaterFurnace pump kits can be used for hydronic heating applications as long as they meet the flow requirements. If the flow requirements are outside the pump curve, an alternate pump will need to be obtained to maintain the necessary flow.

- **24S516-10** - UPS15-42RU composite PPS, 3/4 inch union sweat connection
- **EWPK1** - UP26-99F cast iron volute, 1 inch FPT flange connection
- **EWPK2** - UP26-99SF Stainless Steel volute, 1 inch FPT flange connection
- **EWPK3** - UP26-99F cast iron volute, 1-1/4 inch FPT flange connection

Figure 8: UPS15-42RU and UP26-99F Pump Curve

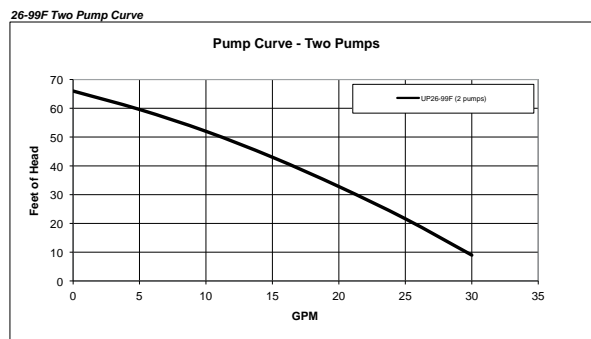
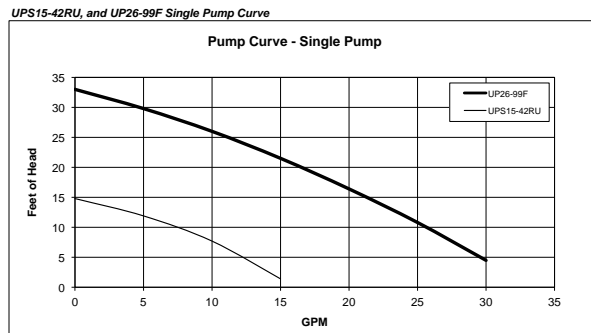

**NOTE:** Never use piping smaller than 1 inch. Limit length of pipe to 50 feet or less.

### Type L Copper Pressure Loss Ft of Hd per 100 ft

GPM	Type L Copper Tube				
	3/4	1	1-1/4	1-1/2	2
2	1.5				
3	3.2				
4	5.5	1.4			
5	8.5	2.1			
6		2.9	1.1		
7		3.9	1.4		
8		5.0	1.8		
9		6.1	2.3	0.9	
10		7.5	2.8	1.1	
12			3.9	1.6	
14			5.2	2.1	
16			6.6	2.7	
18			8.2	3.4	
20			10.0	4.1	1.1
22				5.0	1.3
25				6.3	1.6
30					2.2
35					2.9
40					3.8
45					4.7
50					5.7

**NOTE:** Standard piping practice limits pressure drop to 4 feet of hd per 100 feet in 2 inch and larger pipe.

## External Control

---

An external controller is necessary for operation. For water storage tank set point control the HydroStat HSC, HZC, and HZO were designed specifically for our Geo-Storage Tanks. A field supplied aquastat may also be used as the external control to the heat pump. If zoning is required, the HydroLogic Zone Panels and Control system can provide up to eight zones of closed loop hydronic heating and cooling.

### HydroStat (HSC) features:

- Communicating Controller
- Pump Sampling
- 2 1/2" x 2 1/2" LCD display and five push buttons serve as the human interface
- Controls and regulates water tank temperature
- Fahrenheit or Celsius
- Symphony Compatibility - Without HydroStat the tank temperature won't be displayed on Symphony
- Single Stage

### HydroZone (HZC) features:

- 2 1/2" x 2 1/2" LCD display and five push buttons serve as the human interface
- Controls and regulates water tank temperature
- Fahrenheit or Celsius
- Outdoor reset
- Warm weather shutdown
- Single Stage

### HydroZone (HZO) features:

- HZC mounted on 7.5" x 7.5" x 3.25" electrical box
- HydroZone relay board
- 2 1/2" x 2 1/2" LCD display and five push buttons serve as the human interface
- Controls and regulates water tank temperature
- Fahrenheit or Celsius
- Outdoor reset
- Warm weather shutdown
- Staging (up to 4 stages)
- Lead/Lag (when staging)

### HydroLogic features:

- Operates radiant floor heating
- Operates hydronic fan coil heating and cooling
- 4 zones expandable to 8 zones
- Communicating 2 wire controls
- Controls 2 stages of compressors with rotation
- Controls backup heat source
- Intelligent heat/cool switchover
- Fahrenheit or Celsius
- Outdoor reset
- Indoor temperature feedback
- Warm weather shutdown

## Accessories and Options cont.

Figure 9: Geothermal Storage Tank

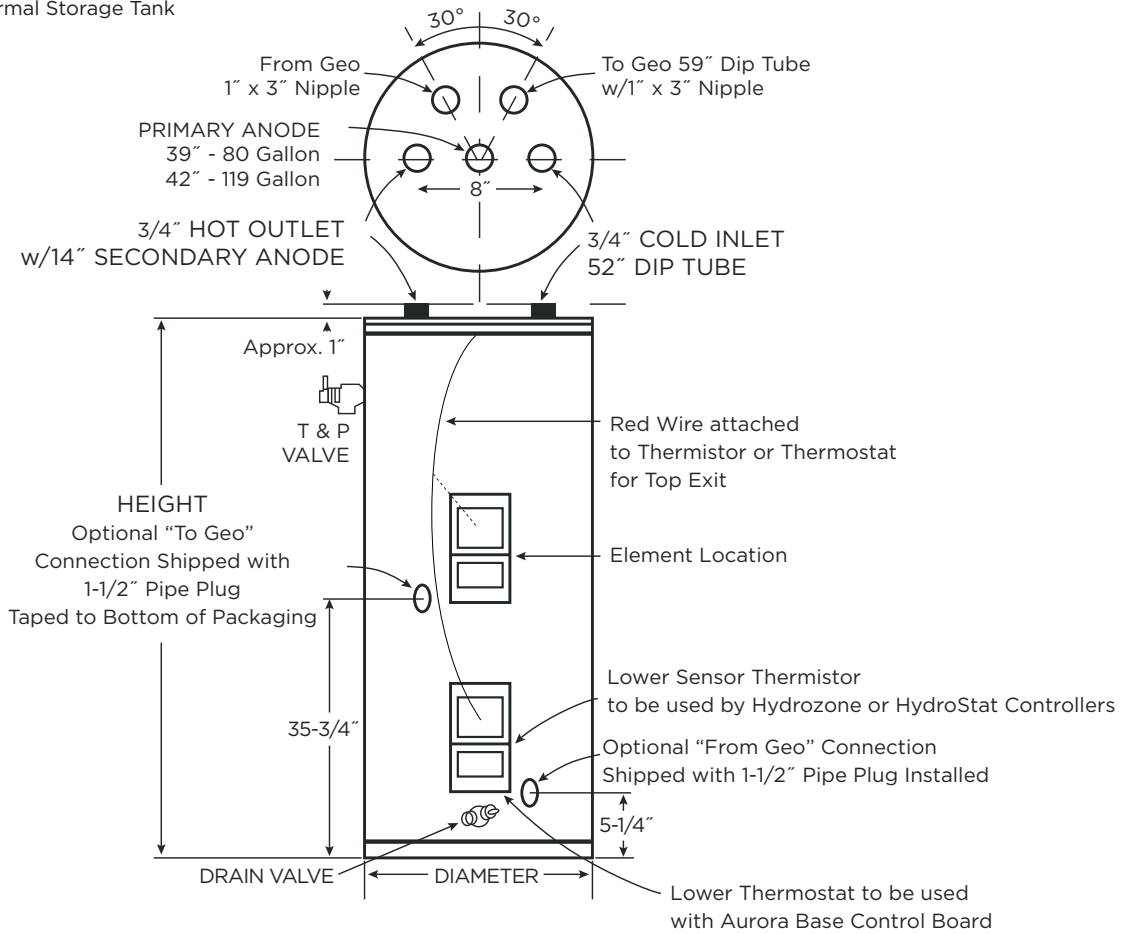

MODEL NUMBER	GALLON CAPACITY	ELEMENT WATTAGE (240 VOLT)	NUMBER OF ELEMENTS	R VALUE	DIMENSIONS IN INCHES		APPROX. SHIPPING WEIGHT (lbs.)
					HEIGHT	DIAMETER	
GEO-STORAGE-80*	80	4500	1	16	63-1/4	24	204
GEO-STORAGE-120**	119	4500	1	16	63-1/4	28	311

\* 040 Only

\*\* 050 & 066 Only

## Engineering Guide Specifications

### General

The liquid source water-to-water heat pump shall be a single packaged heating only or reverse-cycle heating/cooling unit. The unit shall be listed by a nationally recognized safety-testing laboratory or agency, such as ETL Testing Laboratory, Underwriters Laboratory (UL), or Canadian Standards Association (CSA). The unit shall be rated in accordance with Air Conditioning, Heating, and Refrigeration Institute/International Standards Organization (AHRI/ISO) and Canadian Standards Association (CSA-US). The liquid source water-to-water heat pump unit, as manufactured by WaterFurnace International, Fort Wayne, Indiana, shall be designed to operate with source liquid temperatures between 50°F [10°C] and 110°F [43.3°C] in cooling, and between 30°F [-1°C] and 90°F [32.2°C] in heating.

### Casing and Cabinet

The cabinet shall be fabricated from heavy-gauge galvanized steel and finished with corrosion-resistant powder coating. This corrosion protection system shall meet the stringent 1,000 hour salt spray test per ASTM B117. The interior shall be insulated with ½ in. thick, multi-density, coated glass fiber for noise suppression.

All units shall have separate holes and knockouts for entrance of line voltage and low voltage control wiring. All factory-installed wiring passing through factory knockouts and openings shall be protected from sheet metal edges at openings by plastic ferrules. The control box shall be field switchable from front to back for improved application flexibility with quick attach low voltage harnesses. The control box is shipped standard on the opposite end of the water connections.

### Refrigerant Circuit

All units shall utilize the non-ozone depleting and low global warming potential refrigerant R-410A. All units shall contain a sealed refrigerant circuit including a hermetic motor-compressor, bidirectional thermostatic expansion valve, reversing valve, coaxial tube water-to-refrigerant heat exchanger, electronic expansion valve (VI circuit), and service ports.

Compressors shall be high-efficiency scroll type designed for vapor injection, heat pump duty and mounted on vibration isolators. The compressor shall be double isolation mounted using selected durometer grommets to provide vibration free compressor mounting. All models will feature a compressor discharge muffler to help quiet compressor gas pulsations. A high density sound attenuating blanket shall be factory installed around the compressor to reduce sound. Compressor motors shall be single-phase PSC with overload protection.

The coaxial water-to-refrigerant heat exchanger shall be designed for low water pressure drop and constructed of a convoluted copper inner tube and a steel outer tube. Refrigerant-to-water heat exchangers shall be of copper inner water tube and steel refrigerant outer tube design, rated to withstand 650 PSIG (4481 kPa) working refrigerant pressure and 450 PSIG (3101 kPa) working water pressure. The thermostatic expansion valve shall provide proper superheat over the entire liquid temperature range with minimal "hunting." The valve shall operate bidirectionally without the use of check valves.

### Piping and Connections

Supply and return water connections shall be 1 in. [25.4 mm] for the NEW040, 1 ¼ in. [31.75 mm] for the NEW050-066. The FPT fittings shall be fixed to the cabinet by use of a captive fitting, which eliminates the need for backup pipe wrenches.

### Electrical

A control box shall be located within the unit compressor compartment and shall contain a 75VA transformer with a built-in circuit breaker, 24 volt activated compressor contactor, terminal block for thermostat wiring and solid-state controller for complete unit operation. Electromechanical operation WILL NOT be accepted. Units shall be name-plated for use with time delay fuses or HACR circuit breakers. Unit controls shall be 24 volt and provide heating or cooling as required by the remote thermostat/sensor.

An Aurora, a microprocessor-based controller, interfaces with an external control to monitor and control unit operation shall be provided. The unit control shall provide operational sequencing, high and low pressure switch monitoring, freeze detection, hot water limit thermistor sensing, lockout mode control, hot water, load and loop pump control, LED status and fault indicators, fault memory, field selectable options, and accessory output. The Lockout signal output shall have a pulsed option so that DDC systems can red specific lockout conditions from the control.

## Engineering Guide Specifications cont.

The Aurora Advanced Control shall also feature an Energy Monitoring Package that will provide real time total power consumption, compressor monitoring, On Peak input signal for utility controlled demand programs, loop pump linking for multiple units driving a common flow center and up to two optional home automation inputs. Optional Performance and Refrigerant Monitoring package will provide real time data of the refrigeration circuit.

An optional Aurora Interface Diagnostic (AID) Tool shall communicate with the Aurora control allowing quick and easy access to monitoring, and troubleshooting of any Aurora control. The device shall include the features of fault description, and history, manual operation capability, sensor readings, timings, and other diagnostic tools.

A detachable terminal block with screw terminals will be provided for field control wiring. All units shall have knockouts for entrance of low and line voltage wiring.

**Optional IntelliStart (compressor Soft Starter) (040 only)** shall be factory installed for use in applications that require low starting amps, reduced compressor start-up noise, off-grid, and improved start-up behavior. IntelliStart shall reduce normal starting current by 60% on 208-230/60/1 units.

### Accessories

#### Hose Kits - Automatic Balancing and Ball Valves with 'Y' strainer (field-installed)

*WaterFurnace P/N - WFI-AYH100XF-XXX-24MO*

*(1 in. hose kit for 040)*

*WFI-AYH125XF-XXX-24MO*

*(1 1/4 in. hose kit for 050-066)*

A flexible steel braid hose featuring Kevlar® reinforced EPDM core with ANSI 302/304 stainless steel outer braid and fire rated materials per ASTM E 84-00 (NFPA 255, ANSI/UL 723 & UBC 8-1). Ball valve at one end; swivel connector with adapter at the other end (swivel to adapter connection via fiber or EPDM gasket). Swivel connection provides union between heat pump and piping system. The hoses feature brass fittings, stainless steel ferrules. A "y" strainer is provided on one end for fluid straining and integral "blowdown" valve. A full port ball valve shall be provided with integral P/T (pressure/temperature) port on supply hose and automatic balancing valve with integral P/T ports and full port ball valve on return hose.

#### Specifications:

- Temperature range of 35°F [2°C] to 180°F [82°C].
- Max. working pressure of 400 psi [2756 kPa] for 1/2 in. and 3/4 in. hose kits; max. working pressure of 350 psi [2413 kPa] for 1 in. and 1 1/4 in. hose kits.
- Minimum burst pressure of four times working pressure.

#### Geothermal Storage Tanks

Available in 80 or 119 gallon capacities and are specifically designed with large plumbing connections, 2 in. (R-16) insulation, built-in temperature sensor, and *chilled water approved* make these tanks the perfect choice for geothermal hydronic systems. A pair of 1 in. connections on top of the storage tanks allow for easy installation and trouble-free operation in geothermal hot water assist systems. Large 1-1/2 in. FPT re-circulating side connections (shipped with threaded plugs) are included for high-flow water-to-water units. The upper element provides easy use of auxillary/backup heat. Sandhog low Watt density 4500 Watt Incoloy Steel Heating Element is designed to last 2 to 3 times longer than standard copper heating elements. The lower access panel houses a factory installed thermistor for accurate tank set-point control which is ideal for use with our HydroStat or HydroZone controllers.

## Notes

---

## Revision Guide

---

<b>Pages:</b>	<b>Description:</b>	<b>Date:</b>	<b>By:</b>
Misc.	Added Compressor Monitoring kit, misc. updates	15 Feb 2019	JM
30-35	Updated Heating Performance Data	1 May 2015	MA
All	Literature Creation	5 Feb 2015	MA







Manufactured by  
WaterFurnace International, Inc.  
9000 Conservation Way  
Fort Wayne, IN 46809  
[www.waterfurnace.com](http://www.waterfurnace.com)

Product:	<b>5 Series OptiHeat</b>
Type:	Geothermal Hydronic Heat Pump
Size:	3-5 Tons
Document:	Specification Catalog

SC2508WN 02/19